

White Earth Reservation

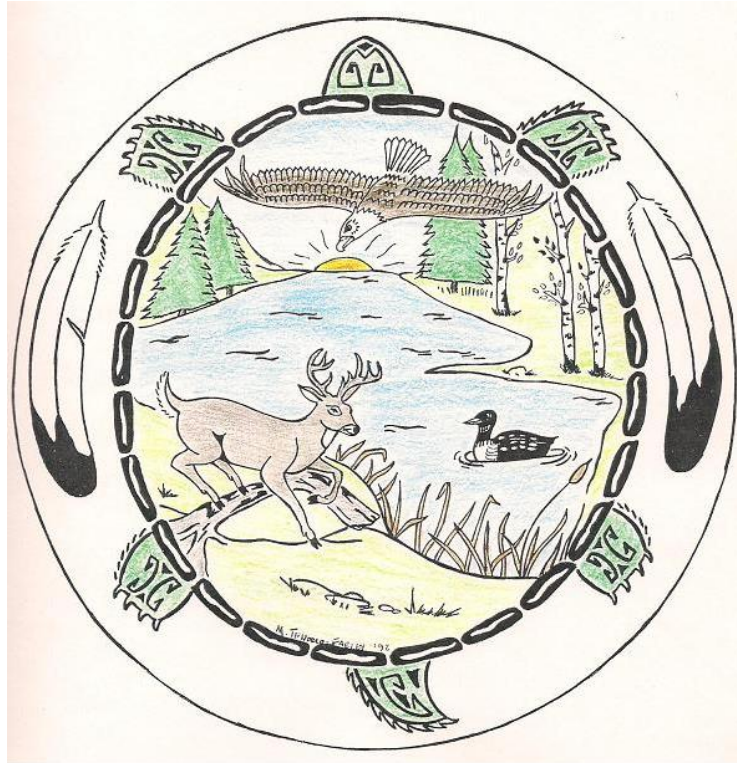

Tribal Conservation Code General



WHITE EARTH RESERVATION TRIBAL COUNCIL
A/K/A WHITE EARTH BUSINESS COMMITTEE
WHITE EARTH BAND OF CHIPPEWA INDIANS

Resolution No. 057-09-005

- WHEREAS,** the White Earth Reservation Tribal Council is the duly elected governing body of the White Earth Reservation pursuant to Article IV, Section 1, of the revised constitution of the Minnesota Chippewa Tribe, as amended, and organized under Section 16, of the Act of June 18, 1934 (48 Stat. 984), and
- WHEREAS,** the White Earth Reservation Tribal Council, also known as the White Earth Reservation Business Committee, is the duly authorized governing body of the White Earth Band, and
- WHEREAS,** that the White Earth Reservation Tribal Council has established the Natural Resource Department which consists of Conservation/Enforcement, Environmental Affairs, Water Quality, Cultural Resources/Archives, Forestry, Land Office, Zoning, Fisheries, Wildlife, Wild Rice and Agriculture, and Pesticides/Emergency Management, and
- WHEREAS,** it is the intent of the White Earth Reservation Tribal Council to effectively, efficiently, and properly manage the natural resources of the White Earth Reservation, and
- WHEREAS,** the White Earth Reservation Conservation Code provides as an enforcement tool whereby natural resources will be protected and enhanced, now

THEREFORE BE IT RESOLVED, that the White Earth Reservation Tribal Council hereby adopts the Revised White Earth Reservation Conservation Code for the protection, management, enforcement, and enhancement of all natural resources within the White Earth Reservation boundaries.

We do hereby certify that the foregoing resolution was adopted by a vote of 4 for, 0 against, 0 silent, a quorum being present at a special meeting of the White Earth Reservation Tribal Council held on June 8, 2009 in White Earth, Minnesota.

Erma J. Vizenor, Chiefwoman

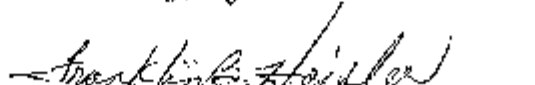
Franklin B. Heisler, Secretary/Treasurer

Record of Revisions

Date	Resolution Number	Reason for Amendment
11/3/2014	057-15-001	To include section on wolf sanctuary and wolf protections.
06/28/2024	057-24-023A	Repeal Tamarac National Wildlife Refuge provisions and amend with Tamarac National Wildlife Refuge Ordinance.

White Earth
Conservation Code

Table of Contents

Preamble

C.C. 100.00 General Information and Provisions

- C.C. 100.01 Name of Code
- C.C. 100.02 Prior Inconsistent Ordinances Repealed
- C.C. 100.03 Amendment of the Conservation Code
- C.C. 100.04 Severability
- C.C. 100.05 Exclusiveness of Offense
- C.C. 100.06 Effective Date
- C.C. 100.07 Jurisdiction
- C.C. 100.08 Enforcement
- C.C. 100.09 Authority

C.C. 101.00 Definitions

C.C. 102.00 General Provisions and Prohibited Acts

C.C. 103.00 Transport Permits

C.C. 200.00 Fishing Provisions

- C.C. 201.00 Fishing Permits
- C.C. 202.00 Fishing Rules and Regulations
- C.C. 203.00 Angling
 - C.C. 203.01 Open Water
 - C.C. 203.02 Angling/Ice
- C.C. 204.00 Spearing/Bow Fishing
 - C.C. 204.01 Spearing/Bow Fishing Non-Game/Rough Fish/Open Water
 - C.C. 204.02 Dark House Spearing/Bow Fishing/Ice
- C.C. 205.00 Dark House/Fish House and Portable Shelters
- C.C. 206.00 Netting

C.C. 300.00 Hunting Provisions

C.C. 301.00 Hunting Permits

- C.C. 301.01 Wolf Hunting and Trapping Prohibited
- C.C. 302.00 Hunting Rules and Regulations
 - C.C. 302.01 Handicapped Hunting Rules and Regulations
- C.C. 303.00 Hunting Seasons

- C.C. 304.00 Firearms/Bow/Crossbow Regulations
- C.C. 304.01 Concealed Carry and/or Permit to Carry
- C.C. 305.00 Artificial Lighting
- C.C. 306.00 Party Hunting
- C.C. 307.00 Motor Vehicles
- C.C. 308.00 Elevated Stands
- C.C. 309.00 Bear
- C.C. 310.00 Migratory Game Bird Hunting Provisions
- C.C. 310.01 Rules and Regulations
- C.C. 310.02 Definitions
- C.C. 310.03 Firearm Regulations
- C.C. 310.04 Hunting Methods
- C.C. 311.00 Trapping Provisions
- C.C. 311.01 Trapping Permit
- C.C. 311.02 Trapping Rules and Regulations

C.C. 400.00 Wild Rice Provisions

C.C. 401.00 Wild Rice Permits

- C.C. 402.00 Wild Rice Rules and Regulations
- C.C. 403.00 Genetically Modified Wild Rice

C.C. 500.00 Tamarac National Wildlife Refuge Ordinance

- C.C. 500.00 General Provisions
- C.C. 500.01 Short Title
- C.C. 500.02 Repeal and Replace
- C.C. 500.03 Conflict with other Tribal Laws
- C.C. 500.04 Declaration of Policy
- C.C. 500.05 Purpose of the Ordinance
- C.C. 500.06 Applicability and Scope
- C.C. 500.07 Authority and Sovereign Immunity
- C.C. 500.08 Effective Date
- C.C. 500.09 Severability
- C.C. 500.10 Definitions
- C.C. 500.11 General Information and Provisions for Activities on the Refuge
- C.C. 500.12 Prohibited, Unlawful, or Restricted Acts on the Refuge
- C.C. 500.13 Inspection and Enforcement Procedures
- C.C. 500.14 Penalties
- C.C. 501.00 Ceremonial Use Regulations
- C.C. 501.01 Ceremonial Use Refuge Permits
- C.C. 501.01 Ceremonial Use Regulations
- C.C. 502.00 Dead & Down Woodcutting Regulations
- C.C. 502.01 Dead & Down Woodcutting Refuge Permits
- C.C. 502.02 Dead & Down Woodcutting Regulations
- C.C. 503.00 Gathering Nontimber Forest Products on the Refuge
- C.C. 503.01 Gathering Nontimber Forest Products Permits
- C.C. 503.02 Gathering Nontimber Forest Products Regulations

- C.C. 504.00 Gathering Traditional Timber Forest Products on the Refuge
- C.C. 504.01 Gathering Traditional Timber Forest Products Permits
- C.C. 504.02 Gathering Traditional Timber Forest Products Regulations
- C.C. 505.00 Harvesting Leeches, Turtles, and Minnows on Refuge Regulations
- C.C. 505.01 Harvesting Leeches, Turtles, and Minnows on Refuge Permits
- C.C. 505.02 Harvesting Leeches, Turtles, and Minnows on Refuge Regulations
- C.C. 505.02A Special Minnow Regulations
- C.C. 506.00 Refuge Furbearer Trapping Regulations
- C.C. 506.01 Trapping Permit Drawing
- C.C. 506.02 Trapping Regulations
- C.C. 507.00 Refuge Manoomin (Wild Rice) Gathering Regulations
- C.C. 507.01 Manoomin Permits
- C.C. 507.02 Manoomin Regulations
- C.C. 508.00 Scientific Research on the Refuge
- C.C. 508.01 Scientific Research Permits
- C.C. 508.02 Scientific Research Regulations

C.C. 600.00 Forestry Provisions

C.C. 601.00 Forestry Permits

- C.C. 602.00 Forestry Rules and Regulations
- C.C. 603.00 Fire and Burning Provisions
- C.C. 603.01 Burning Permits
- C.C. 603.02 Burning Rules and Regulations
- C.C. 603.03 Campfires
- C.C. 603.04 Assisting With Wildfire Suppression, Commandeering Property
- C.C. 603.05 Disposal of Slashing and Debris
- C.C. 603.06 Starting Fires: Burners, Failure to Report a Fire
- C.C. 603.07 Fire Wardens
- C.C. 603.08 Wildfire Prevention and Prohibitions

C.C. 700.00 Raptor Provisions

- C.C. 701.00 Eagles
- C.C. 701.01 Eagle Permit and Eagle Feather Bank
- C.C. 702.00 Commercial Use of Feathers

C.C. 800.00 Recreational Vehicle Provisions

- C.C. 801.00 Boats and Watercraft Registration Provisions
- C.C. 801.01 Boats and Water Craft Registrations
- C.C. 801.02 Boats and Watercraft Rules and Regulations
- C.C. 801.03 Personal Watercraft (PWC) Rules and Regulations
- C.C. 802.00 Off-Highway Vehicles (OHV) Provisions
- C.C. 802.01 OHV Permits

- C.C. 802.02 OHV Rules and Regulations
- C.C. 802.03 All-Terrain Vehicles (ATV's) Rules and Regulations
- C.C. 802.04 Mini-Trucks
- C.C. 802.05 Off-Highway Motorcycles (OHM's) Rules and Regulations
- C.C. 802.06 Off-Road Vehicles (ORV's) Rules and Regulations
- C.C. 802.07 Snowmobiles Rules and Regulations

C.C. 900.00 Parks and Recreation Provisions

- C.C. 901.00 Park Violations
- C.C. 902.00 Fires

C.C. 1000.00 Commercial Provisions

C.C. 1001.00 Commercial Fishing Provisions

C.C. 1001.01 Commercial Non-Game/Rough Fish Harvesting Permit

C.C. 1001.02 Private Game Fish Culture Permit

- C.C. 1001.03 Commercial Bait Fish Aquaculture Permit
- C.C. 1001.04 Fishing Tournaments
- C.C. 1002.00 Leeching Provisions
- C.C. 1002.01 Leeching Permits
- C.C. 1002.02 Leeching Rules and Regulations
- C.C. 1003.00 Turtle Provisions
- C.C. 1003.01 Turtle Permits
- C.C. 1003.02 Turtle Rules and Regulations
- C.C. 1004.00 Commercial Bear Guide Service
- C.C. 1004.01 Rules and Regulations
- C.C. 1005.00 Game Bird Shooting Preserve Provisions
- C.C. 1005.01 Game Bird Shooting Preserve Permits
- C.C. 1005.02 Game Bird Shooting Preserve Rules and Regulations
- C.C. 1005.03 Game Bird Shooting Preserve Seasons and Limits
- C.C. 1006.00 Commercial Big Game Harvest Preserve Provisions
- C.C. 1006.01 Definitions
- C.C. 1006.02 Permit
- C.C. 1006.03 Rules and Regulations
- C.C. 1006.04 Records/Accreditation
- C.C. 1007.00 Commercial Fur Buyer Provisions
- C.C. 1007.01 Commercial Fur Buyer Permits
- C.C. 1007.02 Rules and Regulations
- C.C. 1008.00 Commercial Taxidermy Provisions
- C.C. 1008.01 Commercial Taxidermy Permits
- C.C. 1008.02 Commercial Possession of Wild Animals
- C.C. 1008.03 Transport Permits
- C.C. 1009.00 Commercial Harvest of Aquatic Vegetation
- C.C. 1009.01 Aquatic Vegetation Harvest Permits
- C.C. 1009.02 Aquatic Vegetation Harvest Rules and Regulations
- C.C. 1010.00 Bough Harvesting Provisions
- C.C. 1010.01 Bough Harvesting Permits
- C.C. 1010.02 Bough Harvesting Rules and Regulations

WHITE EARTH RESERVATION CONSERVATION CODE

PREAMBLE

It is the obligation of the White Earth Reservation as a sovereign nation to protect the rights of all its enrolled members. It is recognized that the White Earth Tribal Council has granted the members of the Reservation a right in taking and using of resources found on the Reservation. However, the rights of individuals are subject to regulation by the sovereign to insure that each member has equal access to available resources and to preserve such resources as we now enjoy for use by future generations.

It is also the responsibility of a sovereign nation, through reasonable regulations and management activities, to manage the Reservation's resources to the best of its ability by efficient and effective ways to insure that these resources are managed in a manner as to allow maximum usage while yet maintaining a population at a level capable of regeneration.

It is for these and other purposes that the White Earth Band of Chippewa Indians enacts the following Conservation Code pursuant to their inherent traditional powers and the authority of the Minnesota Chippewa Tribal Constitution, Article 1, Section 3.

These regulations apply to Minnesota Chippewa Tribal members and other permittees. However, because of the unique nature of law enforcement and natural resource management responsibilities, employees of the White Earth Reservation Tribal Council's Natural Resources Department, in carrying out their assigned duty to protect or manage natural resources, shall be exempted from the restrictions herein stated to the extent necessary to fulfill their assigned tasks or job.

C.C. 100.00 General Information and Provisions

C.C. 100.01 Name of Code

This Code shall be known as the White Earth Reservation Conservation Code and may be referred to as the Conservation Code and may be abbreviated as the C.C. All rules and regulations contained herein may be cited by the names given in the ruled headings. The Preamble shall not be considered part of this Ordinance.

C.C. 100.02 Prior Inconsistent Ordinances Repealed

Any and all ordinances of the Reservation Tribal Council which conflict in any way with the provisions of this Code are hereby repealed, to the extent that they are inconsistent with or conflict with, or are contrary to the spirit and/or purpose of the Code.

C.C. 100.03 Amendment of the Conservation Code

The Conservation Code may be amended by the Reservation Tribal Council by adoption of a resolution stating such changes. Additions to this Conservation Code shall become part thereof for all purposes and shall be codified and incorporated herein in a manner consistent with the numbering and organization thereof.

C.C. 100.04 Severability

If any provision of this Code or the application of any provisions of this Code to any person or circumstances is held invalid, the remainder of this Code shall not be affected thereby.

C.C. 100.05 Exclusiveness of Offense

No conduct constitutes an offense unless so declared by this Code or by any other tribal resolution or ordinance. Offenses may be an omission of a requirement or special provision or engaging in a prohibited act.

C.C. 100.06 Effective Date

This Code shall apply to all offenses as herein defined occurring on or after its effective date including amendments, seasons, limits and other regulations established by the Director of Natural Resources or Reservation Tribal Council.

C.C. 100.07 Jurisdiction

Subd.1) The jurisdiction of the White Earth Tribal Court shall extend to all aspects of the Conservation Code and shall extend to all enrolled members of the Minnesota Chippewa Tribe, and to all members of a federally recognized tribe.

Subd.2) The jurisdiction of this Code shall be criminal in nature and the penalties assessed for any violation of any prohibited act contained herein or amendatory thereof shall be in the form of dollar amount fines and/or incarceration and/or loss and/or revocation or resource taking permits and/or seizure of vehicles, boats, guns, fishing equipment and any and all other equipment used during the course of a violation of alleged violation of this Code.

Subd. 3) The jurisdiction of the White Earth Tribal Court shall extend to non-Indians in the case of hunting or trapping violations involving wolves, and such jurisdiction shall be civil in nature. Civil penalties with respect to non-Indians found to have engaged in hunting or trapping violations involving wolves shall be limited to monetary fines not to exceed \$5,000.00 for each offense. Additionally, any equipment, firearms, motor vehicles used during the course of wolf hunting or trapping shall be subject to civil forfeiture.

C.C. 100.08 Enforcement

Notwithstanding any other provision of law, an authorized official or any other persons authorized by the White Earth Reservation Tribal Council that has been deemed to enforce all or part of this Code/Ordinance.

C.C. 100.09 Authority

The foregoing shall not be deemed to limit or restrict the Land Office, Natural Resources Department, or any other person(s) who represents the White Earth Reservation Tribal Court System from taking other appropriate action, including issuance of cease and desist orders, and giving notification to the representative of Federal, Tribal, State, County or municipal government agencies.

C.C. 101.00 Definitions

Subd.1) **Adult:** Shall mean any person 18 years of age or older.

Subd.2) **All-Terrain vehicles (ATV):** Shall include Class 1 and 2 type ATV's.

- Class 1 ATVs:
 - Motorized
 - Flotation tires, at least 3 but no more than 6 low pressure tires
 - Engine displacement of less than 800cc
 - Dry weight of less than 900 pounds

- Class 2 ATVs:
 - Motorized
 - Flotation tires, with at least 3 but no more than 6 low pressure tires
 - Engine displacement of less than 800cc
 - Dry weight of 900-1500 pounds

Subd.3) **Angling:** Shall mean to take, or attempt to take a fish by a hook and line.

Subd.4) **Aquatic Life:** Shall mean plant, or animal life that grows, lives in, or frequents the water.

Subd.5) **Arrow:** Shall mean a projectile released from a bow, which includes both hunting and fishing arrows. The regulation of a bow and arrow will be addressed separately in the hunting and fishing regulations.

Subd.6) **Attended Line:** Shall mean a line used for taking fish that is within 300 feet, and within sight of the person that set the line.

Subd.7) **ATV Safety Certificate:** Shall mean a valid certificate issued by a duly authorized Band or State program, upon completion of a Firearm Safety class.

- Subd.8) **Backfire:** Shall mean a fire intentionally started ahead of, or in the path of, an approaching wildfire for the purpose of burning back toward the wildfire so that when the two fires meet both will die for lack of fuel.
- Subd.9) **Bait:** Shall mean grain, fruit, vegetables, nuts, and hay.
- Subd.10) **Baitfish:** Shall mean all members of the minnow family, except carp and goldfish, all members of the sucker family, yellow perch, herring, gold-eyes, mooneyes, and mud minnows. For purposes of any law regulating the taking, sale, or transportation thereof, leeches, frogs and salamanders shall be considered baitfish.
- Subd.11) **Big Game Animals:** Shall mean deer, bear, elk, and moose.
- Subd.12) **Boat Safety Certificate:** Shall mean a valid certificate issued by a duly authorized Band or State program, upon completion of a Boat Safety class.
- Subd.13) **Bolt:** Shall mean a projectile released from a crossbow similar to an arrow.
- Subd.14) **Bow:** Shall mean any hunting instrument designed for the purpose of propelling arrows, which is drawn, and held by and through the efforts of the person releasing.
- Subd.15) **Bow Fishing:** Shall mean taking or attempting to take fish with a bow designed for fishing, complete with barbed arrows tethered to a reel system that is anchored to the body of the bow. Test pull on the line shall not be less than the size/weight of the fish being taken.
- Subd.16) **Buck Shot:** Shall mean ammunition with more than one projectile inside of the shell casing with projectiles measuring .24 inches or 6.10 millimeters (#4 Buckshot)
- Subd.17) **Burning Ban:** Shall mean a burning ban is put in place when moisture conditions in the vegetation are so low that open burning is difficult to control, and has the potential to spread uncontrollably, endangering lives and property. Commonly, this occurs soon after snowmelt in the spring, but it can also occur in mid to late summer, and in the fall.
- Subd.18) **Burning Restrictions:** shall mean burning restrictions are in place anytime there is not a continuous 3-inch cover of snow. Open burning is allowed, between the hours of 6 PM and 8 AM, with a permit, at the specific location.
- Subd.19) **Campfire:** Shall mean a fire set for cooking and warming, which is not more than three feet in diameter by three feet high, and has had the ground five feet from the base of the fire cleared of all combustible material.
- Subd.20) **Cased:** Shall mean any firearm/bow/crossbow totally encased by a container that is zipped, tied, or sealed in some manner. A handgun in a holster is not considered a cased gun.
- Subd.21) **Ceremonial Fire:** Shall mean a fire set for ceremonial purposes, which is not more than three feet in diameter by three feet high, and has had the ground five feet from the base of the fire cleared of all combustible material.
- Subd.22) **Combined Limit:** Shall mean the total of the Daily Limits of all party members involved in the harvest activity.

Subd.23) **Commercial Purposes:** Shall mean the taking, selling for barter, sale, or exchange for consideration.

Subd.24) **Conservation Officer:** Shall mean any person licensed under Minn. Stat. §626 and/or 25 CFR who is duly authorized and/or employed by the White Earth Reservation Tribal Council to provide enforcement of tribal conservation laws.

Subd.25) **Crossbow:** Shall mean any device using a bow, which once drawn, is held solely by means other than the effort of the person releasing. A crossbow may have either a non-folding or folding stock on the device.

Subd.26) **Daily Limit:** Shall mean the number or quantity of fish, wildlife and other natural resources that may be harvested in a 24-hour period, consistent with the rules and regulations of the harvest activity involved.

Subd.27) **Dark House/Fish House/Shelter:** Shall mean any enclosed shelter placed on the ice of a lake, river, creek, or stream.

Subd.28) **Elder/Senior Citizen:** Shall mean any person over the age of 55 years.

Subd.29) **Fine Shot:** Shall mean ammunition with more than one projectile inside of the shell casing with projectiles measuring a maximum of .23 inches or 5.84 millimeters. (FF)

Subd.30) **Firearm:** Shall mean any rifle, handgun or shotgun, with or without ammunition.

Subd.31) **Firebreak:** Any natural or constructed discontinuity in a fuelbed utilized to segregate, stop and control the spread of fire or to provide or control line from which to make a stand to suppress a fire.

Subd.32) **Firearm Safety Certificate:** Shall mean a valid certificate issued by a duly authorized Band or State program, upon completion of a Firearm Safety class.

Subd.33) **Forest:** Shall mean a plant association predominantly of trees and other woody vegetation occupying an extensive area of land.

Subd.34) **Forest Land:** Shall mean land which is at least ten percent stocked by trees of any size and capable of producing timber, or of exerting an influence on the climate or on the water regime; land from which the trees described above have been removed to less than ten percent stocking and which has not been developed for other use; and afforested areas.

Subd.35) **Forest Officer:** Shall mean an employee or designee of the White Earth Tribal Forestry Program designated by the White Earth Reservation Tribal Council.

Subd.36) **Forest Products:** Shall mean lumber, lath, shingles, crating, ties, bolts, logs, pulpwood, firewood, or other marketable materials obtained from trees.

Subd.37) **Fur Bearing Animals:** Shall mean beaver, otter, mink, muskrat, fisher, fox, coyote, lynx, bobcat, weasel, raccoon, and pine marten.

Subd.38) **Game Animals:** Shall mean all big game animals, small game animals and waterfowl.

Subd.39) **Game Fish:** Shall mean all trout, all crappie, large and small mouth bass, muskellunge and muskellunge hybrid, northern pike, walleye, sauger, sturgeon, and all sunfish.

Subd.40) **Genetically Modified Wild Rice:** shall include but not limited to the act of taking or adding genetic materials in a certain combination to change or modify wild rice.

Subd.41) **Guardian:** Shall mean a legal guardian, or any person 18 years of age or older who is authorized by the parent or legal guardian to supervise the person under the age of 16 years.

Subd.42) **Handicapped/Disabled:** Shall mean a person with either a permanent or temporary physical impairment established by medical evidence proving inability to stand for long periods of time without the aid of crutches, braces, canes, or oxygen tank to aid in breathing, or the inability to use both arms.

Subd.43) **Helmet:** Shall mean any DOT approved helmet which conforms to Federal motor vehicle safety standards and are worn by operators and/or passengers of Off-Highway vehicles or snowmobiles. Standard bicycle helmets and hockey helmets aren't legal helmets for riding these motorized vehicles.

Subd.44) **Hunting:** Shall mean the taking, or attempting to take wildlife by means of a firearm, bow or crossbow.

Subd.45) **Hunting Hours:** Shall mean one-half (1/2) hour before sunrise, to one-half (1/2) hour after sunset.

Subd.46) **Improved Road:** Shall mean any road that has a surface improved by gravel, asphalt or concrete.

Subd.47) **Loaded Gun:** Shall mean any firearm containing ammunition in the magazine or chamber, except the muzzleloader, which is considered to be loaded when the percussion cap is in place.

Subd.48) **Meat:** Shall mean the part of the fish or game animal, which is usually considered and normally consumed as edible.

Subd.49) **Mini-trucks:** Shall mean a motorized vehicle not meeting the definition of Class 2 ATV and can't be licensed for highway use. For the purposes of this Code, mini-trucks will be considered as implements of husbandry when used for such purposes as agriculture, leeching, hunting, fishing, trapping, wood gathering and any other treaty related activity.

Subd.50) **Minor:** Any person under 18 years of age.

Subd.51) **Motor Vehicle:** Shall mean, but not limited to, any car, pickup, automobile, truck, motorized boat, Off Road Recreational Vehicles (ORRV), airplane or any other vehicle that is motorized.

Subd.52) **Natural Resources:** Shall include all animals, fish, wild rice and such other naturally occurring animal or plant as is designated by the White Earth Tribal Council and which are accorded some measure of protection or regulation under the White Earth Conservation Code.

Subd.53) **Natural Resources Harvest Permit:** Shall mean a card/permit issued by the White Earth Licensing Department to enrolled members of the Minnesota Chippewa Tribe and all others who have submitted themselves to the jurisdiction of the White Earth Conservation Code. The permit shall designate the purpose for which it has been issued, what natural resources, game, fur bearing animals, fish or wild rice are covered thereby, and the duration of the permit.

Subd.54) **Navigational Lights:** Lights used for reduced visibility conditions. A 360° white light at the rear of the vessel and combination or side lights to the front. A red light to the left side of the boat and green light to the right side of the boat are required of all boats and watercraft. The red and green lights must shine from

straightforward, backwards to the midpoint of the vessel. While a vessel is anchored all that is required is a 360° white light.

Subd.55) **Non-Game/Rough Fish:** Shall mean all other fish that aren't bait or game fish.

Subd.56) **Non-Toxic Shot:** Shall mean steel shot, copper-, nickel-, or zinc-plated steel shot, bismuth tin shot, tungsten-iron shot, tungsten-nickel-iron shot, tungsten-polymer shot, tungsten-matrix shot, or other shot approved by the White Earth Tribal Council and/or the U.S. Fish and Wildlife Service.

Subd.57) **Off-Highway Motorcycles (OHM):** Shall mean motorized off-highway vehicles traveling on two wheels. OHM's have a seat or saddle designed to be straddled by the operator and have handlebars for steering control. Motorcycles may be legal for highway use and still be considered to be an OHM if used for off-highway operation on trails or natural terrain.

Subd.58) **Off-Highway Vehicle (OHV):** Shall mean All-Terrain vehicles (ATV), Off-Highway motorcycles (OHM), and Off-Road vehicles (ORV).

Subd.59) **Off-Road Vehicles (ORV):** Shall mean motorized recreational vehicles capable of cross country travel on natural terrain, such as four wheel drive trucks. ORV's under 1500 pounds are registered as Class 2 ATV's.

Subd.60) **Open Fire; Open Burning:** Shall mean a fire burning in matter, whether concentrated or dispersed, which is not contained within a fully enclosed firebox, structure or vehicle and from which the products of combustion are emitted directly to the open atmosphere without passing through a stack, duct or chimney.

Subd.61) **Owner:** Shall include the person owning the fee title to any tract of land but does not include an owner of timber thereon or of minerals or any other thing therein when such ownership is separate from the ownership of the surface.

Subd.62) **Paddy or Cultivated Wild Rice:** Product is paddy-grown, mechanically harvested, and of different character and flavor than naturally-grown and hand-harvested true wild rice and is grown in diked paddies.

Subd.63) **Peace Officer:** Shall mean any person licensed under Minn. Stat. §626 who is duly authorized and/or employed by the White Earth Reservation Tribal Council to provide enforcement of tribal laws.

Subd.64) **Person:** Shall mean any natural person acting either personally or in any representative capacity, a corporation, a firm, a co-partnership, or an association of any nature or kind.

Subd.65) **Personal Flotation Devices (PFD's or Life jackets/vests):**

- **Type I—Off-shore jacket**
 - Vest or yoke type device designed to turn most unconscious persons from a face down to a face up position in the water.
- **Type II---Near-shore buoyant vest**
 - Buoyant vest worn like a bib and resembling a horse collar. It has an unconscious turning ability similar to the Type I, but will not turn as many persons under the same conditions.
- **Type III---Flotation aid**

- These devices are usually foam-filled and come in several colors and styles, including full-sleeved jackets. These devices are not designed to turn an unconscious person, but they do provide protection from immersion hypothermia (exposure to cold water).
- **Type IV---Throwable devices (buoyant cushion, ring buoy or horseshoe buoy)**
 - These devices are designed to be thrown to a victim in the water rather than worn
- **Type V---Special use devices**
 - These are designed and approved for restricted uses such as a sailboarding harness, duck hunting flotation coveralls, or a white water rafting vest.

Subd.66) **Personal Use:** Shall mean any use other than Commercial use.

Subd.67) **Personal Watercraft:** Are motorboats powered by an inboard motor powering a jet pump or by an outboard or propeller driven motor and is designed to be operated by a person sitting, standing or kneeling on the craft, rather than in the conventional manner of sitting or standing inside a motorboat. They are sometimes referred to as a PWC or by brand name such as; Jet-Ski, Waverunner, Sea-Doo, etc.

Subd.68) **Pistol bow:** Shall mean any device using a bow, which once drawn, is held solely by means other than the effort of the person releasing. A crossbow is manufactured with a pistol grip and no stock on the device.

Subd.69) **Possession:** Shall mean the act of having, or taking into control, whether on an individual's person, or in his/her vehicle, home, or other structure, or within an area controlled by him/her, or within his/her ability to control. Said control can either be actual, constructive, singularly, or jointly.

Subd.70) **Recreational Fire:** Shall mean a fire set for cooking, warming, or ceremonial purposes, which is not more than three feet in diameter by three feet high, and has had the ground five feet from the base of the fire cleared of all combustible material.

Subd.71) **Registration decal:** Shall mean a valid registration decal issued by the White Earth Licensing Department for the purposes of Off-Highway Vehicles (OHV's), snowmobiles and boats and watercraft. The decal shall consist of the White Earth logo, registration number and expiration date.

Subd.72) **Reservation:** Shall mean the White Earth Reservation as established by an Act of March 19, 1867, 16 Stat. 719, is a government agency incorporated into the Minnesota Chippewa Tribe through the revised constitution and bylaws enacted pursuant to Section 16 of the Indian Reorganization Act of 1934.

Subd.73) **Ricing:** Shall mean the taking of, or attempting to take wild rice.

Subd.74) **Seal(s)/Tag(s):** Shall mean a locking device intended to mark game animals and which is assigned and distributed by either the White Earth Licensing Department or White Earth Natural Resources Department.

Subd.75) **Secure Line:** Shall mean the proper anchoring of equipment used for the taking of fish by the means of a fishing rod holder or other method used for holding such equipment, preventing it from becoming dislodged and falling into the water.

Subd.76) **Slow-no wake speed:** Shall mean 5 mph or less.

Subd.77) **Small Game Animals:** Shall mean rabbits, hares, squirrels, all grouse, pheasant, all partridge, all doves, woodcock, rail and snipe.

Subd.78) **Snow-covered:** Shall mean that the ground has a continuous, unbroken cover of snow, to a depth of three inches or more, surrounding the immediate area of the fire sufficient to keep the fire from spreading.

Subd.79) **Snowmobile:** Shall mean a self-propelled vehicle designed for travel on snow or ice steered by skis or runners.

Subd.80) **Snowmobile Safety Certificate:** Shall mean a valid certificate issued by a duly authorized Band or State program, upon completion of a Snowmobile Safety class.

Subd.81) **Spear:** Shall mean a pole tipped with a minimum of 3 barbed tines that are a minimum of 4-1/2 inches long, with each tine having a barb extending perpendicular which is greater than 1/8 of an inch.

Subd.82) **Spear Gun:** Shall mean a mechanical weapon capable of releasing a projectile similar to a spear either through the use of pneumatic (compressed gas), or the use of elastic bands. Spear tips shall be barbed so the fish can't escape once they are hit and the tips will be tethered to the gun. Breakaway tips separate from the shaft to avoid damage to the spear shaft.

Subd.83) **Take or Taking:** Shall mean the act of harvesting any of the Reservation's natural resources for any purpose.

Subd.84) **Timber:** Shall mean and include trees, saplings, bushes, seedlings, and sprouts from which trees may grow, of every size, nature, kind and description.

Subd.85) **Trapping:** Shall mean the taking of furbearers by a trap or snare.

Subd.86) **Unattended Line:** Shall mean a line used for taking fish that is within 300 feet, but not within sight of the person that set the line.

Subd.87) **Wanton Waste:** Shall mean the intentional destruction of, damage to, or discarding of any natural resource, which is commonly considered consumable, commercial, or saleable as permitted herein.

Subd.88) **Watercraft:** Shall mean, but not limited to, any flotation vehicle that is powered by a mechanical engine.

Subd.89) **Waterfowl:** Shall mean wild ducks, wild geese, coots and mergansers.

Subd.90) **White Earth Tribal Council:** Shall mean the duly constituted, and properly elected, governing body of the White Earth Band of Chippewa Indians.

Subd.91) **White Earth Tribal Court:** Shall mean the Court established by the governing body of the White Earth Band through the adoption of the White Earth Band of Chippewa Judicial Code on November 3, 1997.

Subd.92) **White Earth Tribal Forestry Program (WETFP):** Shall mean the agency duly authorized by the White Earth Reservation Tribal Council having administrative charge and regulatory control of Indian lands, parks, and timber within the Reservation, and of all records pertaining to the performance of those functions. The enumeration of specific powers and duties herein shall not limit or exclude other powers or duties.

Subd.93) **Wildfire:** Shall mean a fire requiring suppression action, burning any forest, brush, grassland, cropland, or any other vegetative material.

Subd.94) **Wildfire Areas:** Shall mean any tract or area of 1,000 or more contiguous acres of trees, brush, grasslands, or other vegetative material where the potential for wildfire exists.

Subd.95) **Wild Rice:** Shall mean a tall aquatic North American perennial grass (*Zizania Aquatica*) that yields an edible grain.

C.C. 102.00 General Provisions and Prohibited Acts

Subd.1) It is deemed a prohibited act, for the purpose of this Code, for any person, political entity, business entity, or governing body, or any of the aforementioned persons, entities, or bodies, to interfere with the lawful enforcement of this Code.

Subd.2) It is deemed a prohibited act to flee, attempt to flee, or fail to stop for an Officer when requested by word, red lights or siren while in the performance of his/her duties.

Subd.3) It is deemed a prohibited act to assault or attempt to assault, or in any manner endanger the health or safety of an Officer or Natural Resources Department worker engaged in the lawful enforcement of this Code or in the performance of his/her duties.

Subd.4) It is prohibited to aid, abet, or help any person who is committing or attempting to commit any act prohibited by this Code. This includes both active and passive acts, and failures to act, which result in a violation of this Code.

Subd.5) It is a prohibited act to tend, disturb, move, damage, obstruct, or interfere with any equipment, activity or person of the White Earth Conservation and/or Natural Resources Department in the performance of the equipments functions or the person's assigned task or duty.

Subd.6) Seasons, limits, and other regulations will be posted on a yearly basis at the White Earth Licensing Department.

Subd.7) It is prohibited to take any natural resources outside of established seasons, limits, or regulations, or without a valid unexpired Tribal Identification Card, Natural Resources Harvest Permit, locking seal/tag, or any other specially required harvest permit, if applicable, except as otherwise provided by this Code or as established by the White Earth Tribal Council.

Subd.8) It is prohibited to hinder, resist arrest, or obstruct a Conservation Officer in the performance of his/her duties.

Subd.9) It is prohibited to falsely impersonate a Conservation Officer.

Subd.10) It is prohibited to discharge a firearm in any manner that is hazardous to human life, health, or property, or within 500 feet of an inhabited dwelling without permission of the owner, or down, across, or from any improved road, or within the boundaries of any city, village, or town.

Subd.11) It is prohibited to use the meat of any game animal or game fish for commercial purposes, unless otherwise permitted under this Code or as authorized by the White Earth Tribal Council.

Subd.12) The White Earth Tribal Council recognizes the special nature of the Tamarac National Wildlife Refuge, Little Elbow Lake Park, Lower Rice Lake Wildlife Management Area, and other natural resources management areas and may adopt certain regulations to preserve the special areas.

Subd.13) The White Earth Tribal Council may, at its discretion, issue special harvest permits to accommodate handicapped persons, special events, ceremonies, or other community occasions.

Subd.14) It is prohibited to use walkie talkies, cell phones, or other radio equipment to take big game or small game.

Subd.15) Committing perjury to prevent lawful enforcement of this code, either for the benefit of you or another person, is strictly prohibited.

Subd.16) Giving false information to a law enforcement officer is prohibited.

Subd.17) Violation of this ordinance may result in a fine, reimbursement of costs incurred, and/or revocation of Natural Resources Harvest Permit, other Tribal licensing, and/or other Tribal privileges.

C.C. 103.00 Transport Permits

Subd.1) All big game seals/tags are authorized Transport Permits.

Subd.2) All valid Natural Resource Harvest Permits are authorized Transport Permits.

Subd.3) All Commercial Permittees must obtain a Transport Permit from the White Earth Natural Resources Department, except for leeching, see Subd.7), **C.C. 1002.02 Leeching Rules and Regulations.**

Subd.4) **Transportation of animals into reservation.** Wild animals lawfully taken, bought, sold, or possessed outside the reservation may be bought or shipped into the reservation unless otherwise provided by law.

C.C. 200.00 Fishing Provisions

C.C. 201.00 Fishing Permits

Subd.1) All persons 16 years of age or older who take fish must have in his/her possession and on his/her person, a valid unexpired Tribal Identification Card, and a valid Natural Resources Harvest Permit, current for the year and hasn't been revoked.

Subd.2) The authority to take fish under the Natural Resources Harvest Permit is non-transferable.

C.C. 202.00 Fishing Rules and Regulations

Subd.1) Fish may be taken by angling within seasons and limits as set forth by the White Earth Tribal Council.

Subd.2) Spearing and archery may be used to take fish within seasons and limits as set forth by the White Earth Tribal Council.

Subd.3) Fish may be taken by netting within seasons and limits as set forth by the White Earth Tribal Council, under **C.C. 206.00 Netting.**

Subd.4) It is prohibited to use carp, goldfish, smelt, alewife, crayfish, or bullheads as live bait for either game, or non-game/rough fish.

Subd.5) It is prohibited to sell either game, or bait fish, except as provided under **C.C. 1001.00 Commercial Fishing Provisions.**

Subd.6) Non-game/rough fish, and turtles taken under the authority of a Natural Resources Harvest Permit may be used for commercial purposes.

Subd.7) It is prohibited to transport, or possess fish taken in violation of this Code.

Subd.8) It is prohibited to stock, or place into any waters, any fish without a Stocking Permit issued by the White Earth Natural Resources Department.

Subd.9) It is prohibited to take the spawn of game fish, or non-game/rough fish for the purpose of culture, or propagation under the authority of the Natural Resources Harvest Permit.

Subd.10) Except as otherwise specifically permitted, and during the seasons established by the White Earth Tribal Council, it is prohibited for anyone to have in his/her possession, in any motor vehicle, or on his/her person, at or near waters, a spear, spear gun, bow, net, or any device, or substance capable of taking fish.

Subd.11) It is prohibited to cast the rays of an artificial light on any lake, creek, stream, or river for the purpose of locating, taking, attempting to take fish while in the possession of a spear, spear gun, firearm, crossbow, or bow, except within the seasons and limits as established by the White Earth Tribal Council.

Subd.12) Wanton waste of fish and other aquatic life is prohibited.

Subd.13) The White Earth Natural Resources Department may open, or close any body of water, to any method of taking fish, if the fish are in imminent danger of death, or if the fish population is in danger of over harvest.

Subd.14) Firearms, explosives, poison, or any electric shock equipment shall not be used for the harvest of fish at any time.

C.C. 203.00 Angling

C.C. 203.01 Open Water

Subd.1) Each unattended line must have the owner's full name and Tribal Identification Number clearly marked on the equipment being used.

Subd.2) Each unattended line shall be securely anchored, so as not to be dislodged by a hooked fish.

Subd.3) Unattended lines shall be within 300 feet of the owner at all times.

C.C. 203.02 Angling/Ice

Subd.1) It is prohibited to leave unattended line over night.

Subd.2) Each unattended line shall be securely anchored, so as not to be dislodged by a hooked fish.

Subd.3) Any unattended line or equipment not within 500 feet of its owner will be confiscated.

Subd.4) Holes used for angling through the ice shall not exceed 12 inches in diameter.

C.C. 204.00 Spearing/Bow Fishing

C.C. 204.01 Spearing/Bow Fishing Non-Game/Rough Fish/Open Water

Subd.1) Non-game/rough fish may be taken by spearing/bow fishing within seasons, limits and methods as set forth by the White Earth Tribal Council.

Subd.2) The use of artificial lights while spearing/bow fishing non-game/rough fish is permitted within seasons and limits as set forth by the White Earth Tribal Council.

Subd.3) Fish shall not be taken with a spear that does not meet the requirements of **Subd.81)**, **C.C. 101.00 Definitions.**

Subd.4) Fish shall not be taken with a spear gun that does not meet the requirements of **Subd.82)**, **C.C. 101.00 Definitions.**

Subd.5) Fish shall not be taken by archery unless such equipment meets the requirements of **Subd.15)**, **C.C. 101.00 Definitions.**

Subd.6) Spearing of game fish is prohibited during this season.

C.C. 204.02 Dark House Spearing/Bow Fishing/Ice

Subd.1) Game fish, non-game/rough fish may be taken with a spear, while dark house, fish house, or shelter spearing within the seasons and limits as set forth by the White Earth Tribal Council.

Subd.2) Spearing holes shall not exceed 24 inches by 36 inches.

Subd.3) When the dark house, fish house, or shelter is moved, open spearing holes shall be clearly marked by a natural object such as a tree branch, at least one foot above the snow line, in order to be seen by other fishermen, or vehicular traffic.

Subd.4) When the dark house, fish house, or shelter is moved, ice blocks from the spearing holes shall either be broken into small pieces, pushed back into the open holes, or clearly marked with a natural object such as a tree branch, at least one foot above the top of the block(s), in order to be seen by other fishermen or vehicular traffic.

Subd.5) Fish shall not be taken with a spear that does not meet the requirements of **Subd.81)**, **C.C. 101.00 Definitions.**

Subd.6) Fish shall not be taken with a spear gun that does not meet the requirements of **Subd.82)**, **C.C. 101.00 Definitions.**

Subd.7) Spearing/bow fishing outside of a shelter or on the open ice is prohibited.

C.C. 205.00 Dark House/Fish House and Portable Shelters

Subd.1) Each dark house, fish house, or portable shelter must have attached to the door side of the structure, the owner's full name and city of residence plainly marked with letters and numbers at least 2 inches in height.

Subd.2) Dark houses, fish houses, and portable shelters left on the ice overnight must have at least 2 square inches of reflective material on each side of the structure.

Subd.3) Unoccupied dark houses, fish houses, portable shelters, or portions thereof, shall not be on any body of water between March 15, and ice breakup of each year.

Subd.4) Dark houses, fish houses, and portable shelters shall not be erected within 10 feet of another existing structure.

C.C. 206.00 Netting

Subd.1) Nets shall not be placed within 50 feet of a previously set net of another permittee.

Subd.2) Nets shall not be placed in, or within 300 feet of a river, channel, stream, inlet, or outlet of a lake.

Subd.3) Nets set in Reservation lakes must be checked at least once every 48 hours.

Subd.4) It is prohibited to tend, disturb, move, damage, obstruct, or interfere with any nets of any permittee, unless that permittee is present.

C.C. 300.00 Hunting Provisions

C.C. 301.00 Hunting Permits

Subd.1) All persons 12 years of age or older who take game animals must have in his/her possession, and on his/her person, a valid unexpired Tribal Identification Card, and a valid Natural Resources Harvest Permit.

Subd.2) All persons under 12 years of age aren't required to have a Tribal ID card and/or Natural Resources Harvest Permit to participate in a hunting activity, but must be within arm's reach of a properly licensed parent and/or guardian while learning the harvesting activity.

Subd.3) In addition to the requirements set in Subdivision 1, any person under 16 shall have in his/her possession, and on his/her person, a valid Firearms Safety Certificate issued either by the State or a duly authorized Band official.

Subd.4) Any person under the age of 14 years that has met the requirements of Subdivisions 1, and 2, must be accompanied by a parent and/or guardian that has met the requirements of Subdivision 1, and shall be responsible and liable for the actions of that minor.

Subd.5) Any person exercising their Handicapped Hunting privileges must have in his/her possession and on his/her person, a signed Doctor's statement or a Permanent Handicapped Parking Permit clarifying either a temporary or permanent disability, a valid unexpired Tribal Identification Card, and a valid Natural Resources Harvest Permit, which is stamped 'HANDICAPPED' by the White Earth Licensing Department.

C.C. 302.00 Hunting Rules and Regulations

Subd.1) A locking seal(s)/tag(s) provided by the White Earth Licensing Department must be attached and locked onto any big game animal prior to the animal being moved by a motorized vehicle, or upon arrival at a dwelling or campsite. The tag must be attached such that the tag cannot be removed or reused.

Subd.2) It is prohibited to take big game animals with the aid of dogs or horses.

Subd.3) During the modern firearms season, both small and big game hunters must wear a vest style article of clothing with a minimum of 300 square inches of blaze orange material.

Subd.4) It is prohibited to intentionally chase, drive, or run over any animal with a motor vehicle.

Subd.5) Game animals may be hunted during legal hunting hours only, which are one-half (1/2) hour before sunrise to one-half (1/2) hour after sunset.

Subd.6) It is prohibited to sell the meat from any game animal. The hide, head, antlers, hooves, feet, claws, or teeth of any game animal legally taken and/or registered pursuant to this Code, may be sold.

Subd.7) No person may take ducks, geese, mergansers, coots, or moorhens with lead shot or while having lead shot in possession. Lead shot may be used for hunting other small game in accordance with firearms restrictions.

Subd.8) Use or possession of lead shot while hunting in designated areas of Federal Wildlife Refuges, Waterfowl Production Areas (WPA's), Lower Rice Lake Management Area, Wildlife Management Areas (WMA's) and Scientific and Natural Areas (SNA's) is strictly prohibited.

Subd.9) It is prohibited to use bait or other food transported and placed for the purpose of attracting or enticing deer. Liquid scents, salt and minerals are not considered bait.

Subd.10) A person in the vicinity of a motor vehicle may not shoot a firearm or an arrow from a bow/crossbow unless that person is at least 15 feet from the vehicle and the vehicle engine is shut off.

Subd.11) A person may not prevent or disrupt another person from lawfully taking or preparing to take a wild animal, either by disturbing or interfering with the person hunting or by disturbing the wild animal.

Subd.12) Placing bait for the purpose of preventing a person from lawfully hunting a wild animal would be considered unlawful.

Subd.13) A person may not possess any kind of night vision equipment while taking or attempting to take a wild animal or while possessing a firearm, bow, crossbow or other implement that could be used to take wild animals.

Subd.14) A person transporting a firearm, bow or crossbow in or on a motor vehicle, after or before legal hunting hours, must have the firearm, bow or crossbow, unloaded or unstrung and fully cased in the trunk or rearmost portion of the vehicle.

Subd.15) A person or hunting party is prohibited from hunting within 500 feet of an inhabited dwelling without permission of the owner.

Subd.16) It is prohibited to use walkie talkies, cell phones, or other radio equipment to take big game or small game.

C.C. 302.01 Handicapped Hunting Rules and Regulations

Subd.1) Firearm/Bow/Crossbow may only be loaded/strung/cocked while the vehicle is stationary, without the engine running, and the keys removed from the ignition.

Subd.2) Firearm/Bow/Crossbow must not be loaded/strung/cocked during transition from one place to another.

Subd.3) Each handicapped person may be accompanied by an able-bodied person who has in his/her possession, and on his/her person, a valid unexpired Tribal Identification Card.

Subd.4) No more than 2 persons are allowed inside the stationary vehicle while a person is exercising his/her Handicapped Hunting privileges.

Subd.5) The able-bodied person is to assist only in the loading/unloading of the game animals.

Subd.6) Crossbows may only be used for big game hunting, providing that the regulations in Subds. 3 & 4, **C.C. 304.00 Firearm/Bow/Crossbow Regulations** are met.

Subd.7) The Handicapped Hunting Rules and Regulations listed herein will be followed along with all other hunting rules and regulations listed in this Conservation Code.

C.C. 303.00 Hunting Seasons

Subd.1) It is prohibited to take game animals by any means except by hunting within seasons and limits as established by the White Earth Reservation Tribal Council.

Subd.2) Furbearers may be taken by hunting within seasons and limits as established by the White Earth Reservation Tribal Council. See Subd.6), **C.C. 102.00 General Provisions and Prohibited Acts**

C.C. 303.01 Wolf Hunting and Trapping Prohibited

Absolutely no hunting or trapping of wolves by Indians or non-Indians is permitted on any lands within the exterior boundaries of the White Earth Reservation.

By formal action on August 20, 2012, the governing body of the White Earth Band declared all territory within the exterior boundaries of the White Earth Reservation a Ma'iingan or Wolf Sanctuary. No hunting or trapping of Ma'iingan shall be allowed within the original 1867 exterior boundaries of the White Earth Reservation.

C.C. 304.00 Firearms/Bow/Crossbow Regulations

Subd.1) A person may take big game animals with a firearm only if the rifle, shotgun or handgun used is at least .220 calibers and with center-fire ignition.

Subd.2) It is prohibited to take big game animals with rimfire ammunition including .22 caliber short, long, long rifle, or .22 magnum, or with a shotgun using fine shot ammunition, or with a muzzle loading musket of less than .40 caliber.

Subd.3) Crossbow and Bow hunting for big game shall be permissible provided that the provisions addressing such equipment and other conditions of this Code are complied with. Bows/Crossbows must have a pull of no less than 30 pounds at or before full draw for any big game animal.

Subd.4) Arrow heads for big game hunting must be made of an all steel barbless design, and should be kept sharp, with at least 2 cutting edges, with a diameter of at least 7/8 of an inch.

Subd.5) Waterfowl may be taken with a shotgun only, which is no larger than 10 gauge in size, using fine shot ammunition of any size, which does not contain lead.

Subd.6) Small game and furbearers (with the exception of fox and coyote) may be taken with either a shotgun which has fine shot ammunition; a rifle or handgun that is smaller than .220 caliber center-fire ammunition. Fox and coyote maybe taken with any firearm and ammunition as deemed legal within this document.

Subd.7) Persons age 18 or older may carry a handgun in the woods and fields or upon waters to hunt or target shoot.

Subd.8) It is prohibited for a persons under age 18 to carry a handgun for hunting unless they are in the actual presence or under the direct supervision of the person's parent or guardian, and if they meet firearms safety requirements.

Subd.9) A person may not possess a firearm while bow hunting for deer. A person may take bear, elk and moose by archery while in possession of a firearm.

C.C. 304.01 Concealed Carry and/or Permit to Carry

Subd.1) Persons with a valid Concealed Carry Permit and/or Permit to Carry may generally carry their handguns uncased and loaded while hunting or trapping, or while traveling to and from hunting and trapping locations.

Subd.2) Concealed Carry Permits and/or Permits to Carry must be on his/her person and in his/her possession while carrying a handgun.

Subd.3) It is prohibited for anyone to possess a handgun while using an artificial light or while hunting deer by archery, unless allowed by regulation or permit.

C.C. 305.00 Artificial Lighting

Subd.1) It is prohibited to cast the rays of a spotlight, headlight, or other artificial light onto a highway or into a field, woodland, forest, river creek, or stream for the taking of any game animal, including furbearers while in the possession of a firearm, bow, or crossbow. Exceptions to this rule are:

- a) A firearm that is unloaded, cased, and in the trunk of a motor vehicle. If the vehicle doesn't have a trunk, the firearm must be in the rearmost portion of the vehicle.
- b) A bow or crossbow that is unstrung, cased, and in the trunk of a motor vehicle. If the vehicle doesn't have a trunk, the bow or crossbow must be in the rearmost portion of the vehicle.

- c) A person is permitted to possess an artificial light to aid in the taking of raccoons that have been treed, while the hunter is on foot, and is in possession of a firearm not larger than .22 calibers, or a shotgun with shot ammunition.
- d) Bows/arrows, spears and spear guns may be used with artificial lights for fishing or spearing, during the fishing and spearing seasons and limits, as set forth by the White Earth Tribal Council.
- e) Artificial lighting may be used during Non-game/Rough fish spearing seasons and limits as set forth by the White Earth Tribal Council.
- f) Lights may be used while doing any agricultural, occupational, or recreational activity, including snowmobiling, not related to spotting, locating, or taking any game animals.
- g) Artificial lighting may be used for the control of nuisance beavers as permitted by the White Earth Natural Resources Department.

Subd.2) With or without a firearm, bow or crossbow, no person shall cast the rays of a spotlight, headlight, or other artificial light into a field, woodland, or forest to spot, locate, or take any game animals between the hours of 10:00 p.m. and 6:00 a.m. from September 1 to December 31.

Subd.3) With or without a firearm, bow or crossbow, between the hours of 6:00 p.m. and 6:00 a.m., a person may not project a spotlight or hand-held light from a motor vehicle except for the following purposes:

- a) Safety
- b) Emergency response
- c) Normal vehicle operations
- d) Performing an occupational duty

Subd.4) With or without a firearm, bow or crossbow, between one half hour after sunset until sunrise, a person may not cast the rays of a spotlight, headlight, or other artificial light to spot, locate, or take game animals on fenced agricultural land containing livestock or poultry that is marked with signs prohibiting the shining of lights. Signs will meet the following criteria:

- a) Reflectorized lettering at least 2 inches in height
- b) Display “No shining” or similar terms
- c) Placed at intervals of 1000 feet or less along the boundary of the area

C.C. 306.00 Party Hunting

Subd.1) Deer may be taken for any enrolled member of the White Earth Band, even those who are not present and who have given his/her valid Natural Resources Harvest Permit, and deer tag(s)/seal(s), to another enrolled White Earth member who is doing the hunting for them.

Subd.2) Deer and/or small game may be taken for another person in the hunting party provided that the 2 or more persons are hunting together, and each person has a valid unexpired Tribal Identification Card, a Natural Resources Harvest Permit, and tag(s)/seal(s), if applicable. The combined limit of animals taken shall not **exceed the number of persons in the party.**

C.C. 307.00 Motor Vehicles

Subd.1) It is prohibited to carry or possess a loaded firearm, strung bow, or crossbow in a motor vehicle.

Subd.2) It is prohibited to carry or possess an uncased firearm, bow, or crossbow in a motor vehicle after or before legal hunting hours.

Subd.3) It is prohibited to take, attempt to take, or pursue game animals or furbearers from a motor vehicle, except that waterfowl may be taken from a motorized boat with the engine raised and shut off.

C.C. 308.00 Elevated Stands

Subd.1) No person may take deer from a constructed platform (floor) or other structure that is higher than 16 feet. This restriction does not apply to a portable stand that is chained, belted, clamped, or tied with a rope.

Subd.2) In special areas, this includes: Lower Rice Lake Wildlife Management Area, Scientific and Natural Areas, Wildlife Management areas, Waterfowl Production Areas, State Parks, and State Forests.

- a) Only portable stands may be used.
- b) Stands must not be left over night.
- c) Any unoccupied, permanent or portable stand or blind left on public or Tribal land is open for public use and is not the property of the person who constructed or placed the stand.
- d) Any use of threat or force against another person to gain possession of a stand is unlawful.
- e) All stands must be removed within three days after close of hunting season.

C.C. 309.00 Bear

Subd.1) It is prohibited to bait or hunt for bear prior to the dates set by the White Earth Tribal Council.

Subd.2) Bear may only be baited with biodegradable products including, but not limited to, pastries, rolls, breads, meats oils, scents, bones, and similar items. All baits shall be placed in a pollution free, and nuisance free manner.

Subd.3) It is prohibited to take bear cubs or a female bear accompanied by her cubs.

Subd.4) Bear baiting and hunting, is not allowed within 500 feet of a dwelling without the permission of the landowner or occupant.

Subd.5) All bait stations shall be legibly marked on a 6" x 10" sign with the owner's name, address, Tribal Enrollment number, and telephone number. Signs must be within 10 feet of the bait, and 6 to 10 feet above the ground.

Subd.6) All bait material and signs must be properly disposed of within 48 hours of the last day of the season.

Subd.7) Any bear taken must be registered with the White Earth Conservation Department within 24 hours of the kill. A possession tag will be issued upon registration.

Subd.8) Seasons and limits will be posted upon approval from the White Earth Tribal Council.

Subd.9) Tamarac National Wildlife Refuge is closed to bear baiting/hunting.

C.C. 310.00 Migratory Game Bird Hunting Provisions

C.C. 310.01 Rules and Regulations

Subd.1) Scope of Regulation - The regulations contained in this part relate only to the hunting of migratory game birds.

Subd.2) Implementation of 50 CFR 10 & 50 CFR 20 - This section implements the Migratory Bird Treaty Act (16 U.S. §703-712), 50 CFR 10, listed for the protection of migratory game birds, migratory insectivorous birds and other migratory non-game birds & 50 CFR 20 Migratory Bird Hunting Provisions. (Copy may be obtained from White Earth Reservation Natural Resources Department).

Subd.3) Reference to White Earth Conservation Code, Hunting Provisions - This section implements White Earth Conservation Code, **C.C. 300.00, Hunting Provisions**.

Subd.4) Closed Seasons - No person may take migratory game birds during the closed season.

Subd.5) Shooting Hours - Migratory game birds may be taken during open season one-half hour before sunrise to one-half hour after sunset.

Subd.6) Wanton Waste of Migratory Game Birds - No person may take or attempt to take any migratory game bird under this part without making a reasonable effort to retrieve the bird, and retain it in his or her actual field possession limit.

Subd.7) Field Possession Limit - No person may possess, have in custody, or transport more than the daily limit of migratory game birds, at or between the place where taken and:

- a) His or her automobile or principal means of land transportation; or
- b) His or her personal abode or temporary or transient place of lodging; or
- c) A migratory bird preservation facility; or
- d) A post office; or
- e) A common carrier facility.

Subd.8) Possession of Live Birds - Every migratory game bird wounded and reduced to possession by the hunter must be immediately killed and become a part of the daily bag limit. No person may at any time, or by any means, possess or transport live migratory game birds taken under authority of this part.

Subd.9) Transportation of Birds of Another - No person may transport migratory game birds belonging to another person.

Subd.10) Species Identification Requirement - No person may transport within the United States any migratory game birds, except doves and band-tailed pigeons (*Columba fasciata*), unless the head and/or one fully-feathered wing remains attached to each such bird at all times while being transported from the place where taken until they have arrived at the personal abode of the possessor or a migratory bird preservation facility.

C.C. 310.02 Definitions

For the purpose of this part, the following terms will be construed, respectively, to mean and to include:

- a) Closed Season: Means the days on which migratory game birds cannot be taken.
- b) Commercial Use: Means the taking or selling for barter, sale or exchange for consideration.
- c) Daily Bag Limit: Means the maximum number of migratory game birds permitted to be taken by one person in any day one day during the open season.
- d) Falconry: Means the art of using birds of prey to hunt wild game.
- e) Firearm: Means any crossbow, rifle, handgun or shotgun, with or without ammunition.
- f) Hunting: Means the taking or attempting to take migratory game birds by means of a firearm or bow.
- g) Migratory Bird Preservation Facility: Means:

- 1) Any person, who, at his or her residence or place of business and for hire or other consideration; or
- 2) Any taxidermist, cold-storage facility or locker plant which, for hire or other consideration; or
- 3) Any hunting club which, in the normal course of operations; receives possesses, or has in custody any migratory game birds belonging to another person for purposes of picking, cleaning, freezing, processing, storage or shipment.

h) Migratory Game Birds: Means those migratory birds included in the terms of conventions between the United States and any foreign country for the protection of migratory birds, for which open seasons are prescribed in this part and belong to the following families:

- 1) Anatidae (ducks, geese, brant and swans);
- 2) Columbidae (doves and pigeons);
- 3) Gruidae (little brown cranes);
- 4) Rallidae (rails, coots, and gallinules); and
- 5) Scolopacidae (woodcock and snipe).

i) Motor Vehicle: Shall mean, but not limited to, any car, pickup, automobile, truck, motorized boat, Off-Highway Vehicles (OHV), airplane or any other vehicle that is motorized.

j) Natural Resources: Shall include all animals, fish, wild rice and such other naturally occurring animal or plant as is designated by the White Earth Tribal Council and which are accorded some measure of protection or regulation under the White Earth Conservation Code.

k) Nontoxic Shot: Any shot type that does not cause sickness and death when ingested by migratory birds as determined by established under 50 CFR 20 § 20.134. Only steel shot, bismuth-tin shot, tungsten-polymer shot, tungsten matrix shots, tungsten-iron shot, tin or copper-, nickel- or zinc-plated steel shot (or other nontoxic shot approved by the director of the U.S. Fish & Wildlife Service).

l) Nontoxic Shot Zone: All water areas within the boundaries of the White Earth Reservation are considered nontoxic shot zones for waterfowl hunting. All lands within WPA, WMA, SNA, and Lower Rice Lake Management Area.

m) Open Season: Means the days on which migratory birds may lawfully be taken. Each period prescribed as an open season will be construed to include the first and last days thereof.

n) Personal Use: Means any use other than commercial use.

o) Possession: Means the act of having or taking into control, whether on an individual's person or in his or her vehicle, home or other structure, or within an area controlled by him or her or within his or her ability to control. Said control can either be actual, constructive, singularly or jointly.

p) Raptor: Means a live bird of the families Falconidae, Accipitridae, Tytonidae and Strigidae.

- q) Taking: Means the act of pursuing, hunting, shooting, wounding, killing, trapping, capturing, or collecting, or attempting to pursue, hunt, shoot, would, kill, trap, capture, or collect any of the White Earth Reservation's natural resources for any purpose.
- r) Wanton Waste: Shall mean the intentional destruction of, damage to, or discarding of any natural resource, which is commonly considered consumable, commercial, or saleable as permitted herein.
- s) Waterfowl: Means Anatidae (ducks, merganser, geese [including brant], and coots (Full Americana).
- t) White Earth Reservation: Means the White Earth Reservation, as established by an Act of March 19, 1867, 16 State. 719, is a government agency incorporated into the Minnesota Chippewa Tribe under Federal Charter pursuant to the Indian Reorganization Act of 1934.
- u) White Earth Reservation Natural Resources Department: Means the tribal governmental agency duly authorized by the White Earth Reservation Tribal Council having administrative charge and regulatory control over all natural resources within the White Earth Reservation. The enumeration of specific powers and duties herein will not limit or exclude other powers or duties.
- v) White Earth Reservation Conservation Department: Means the tribal government agency duly authorized by the White Earth Reservation Tribal Council having enforcement authority of the White Earth Conservation Code through enactment 25 CFR and or Minnesota Statute § 626 and any other code, law, or ordinance having the effect on the natural resources within the White Earth Reservation. The enumeration of specific powers and duties herein will not limit or exclude other powers or duties.
- w) White Earth Reservation Tribal Council: Means the duly constituted and properly elected governing body of the White Earth Ojibwe Nation.

C.C. 310.03 Firearm Regulations

Subd.1) Waterfowl may only be taken by a shotgun not larger than 10 gauge in size using fine shot ammunition of any size which does not contain lead and is nontoxic as defined in Section 4(k) above.

Subd.2) Migratory birds may not be taken with a shotgun of any description capable of holding more than five shells, unless it is plugged with one-piece filler, incapable of removal without disassembling the gun, so its total capacity does not exceed five shells.

C.C. 310.04 Hunting Methods

Subd.1) Migratory birds on which open seasons are prescribed in this part may be taken by any method except those prohibited in this section. No person may take migratory birds:

- a) With a trap, snare, net rifle, pistol, swivel gun, shotgun larger than 10 gauge, punt gun, battery gun, machine gun, fish hook, poison, drug, explosive, or stupefying substance;
- b) From or by means, aid, or use of a sink box or any other type of low floating device, having a depression affording the hunter a means of concealment beneath the surface of the water;
- c) From or by means, aid, or use of any motor vehicle, motor-driven land conveyance, or aircraft of any kind, except that paraplegics and persons missing one or both legs may take from any stationary motor vehicle or stationary motor-driven land conveyance;
- d) From or by means of any motorboat or other craft having a motor attached, or any sailboat, unless the motor has been completely shut off and/or the sails furled, and its progress therefrom has ceased, provided that a craft under power may be used to retrieve dead or crippled birds; however, crippled birds may not be shot from such craft under power;
- e) By means or aid of any motor-driven land, water, or air conveyance, or any sailboat used for the purpose of resulting in the concentrating, driving, rallying, or stirring up of any migratory bird;
- f) By the use of aid or live birds as decoys; although not limited to, it will be a violation of this paragraph for any person to take migratory waterfowl on an area where tame or captive live ducks or

geese are present unless such birds are and have been for a period of ten (10) consecutive days prior to such taking, confined within an enclosure which substantially reduces the audibility of their calls and totally conceals such birds from the sight of wild migratory waterfowl;

g) By the use or aid of recorded or electrically amplified bird calls or sounds, or recorded or electrically amplified imitations of bird calls or sounds;

h) By the aid of baiting, or on or over any baited area. As used in this paragraph, “baiting” will mean placing, exposing, depositing, distributing, or scattering of shelled, shucked, or unshucked corn, wheat or other grain, salt or other feed so as to constitute for such birds a lure, attraction or enticement to, on or over any areas where hunters are attempting to take them; and “baited area” means any area where shelled, shucked, or unshucked corn, wheat or other grain, salt or other feed whatsoever capable of luring, attracting, or enticing such birds is directly or indirectly placed, exposed, deposited, distributed or scattered;

i) While possessing shot (either in shotshells or as loose shot for muzzleloading) other than nontoxic shot as described in Section 4(k) above. Provided that:

1) This restriction applies only to the taking of Anatidae (ducks, merganser, geese [including brant], and coots (*Fulica Americana*)).

2) Nontoxic shot is required for the purpose of hunting or taking waterfowl with a muzzleloader (loose shot).

C.C. 311.00 Trapping Provisions

C.C. 311.01 Trapping Permit

Subd.1) All persons 12 years of age or older who take furbearers must have in his/her possession, and on his/her person a valid unexpired Tribal Identification Card, and a valid Natural Resources Harvest Permit.

Subd.2) It is prohibited for any person under the age of 12 years to carry a firearm while trapping.

Subd.3) Any person under 18 years of age who takes furbearers while in possession of a firearm shall have in his/her possession and on his/her person a valid Firearm’s Safety Certificate issued by either the State or a duly authorized Band.

C.C. 311.02 Trapping Rules and Regulations

Subd.1) It is prohibited to take or trap fur bearing animals outside of established seasons, methods, or over established limit, as set by the White Earth Tribal Council.

Subd.2) Each permittee must obtain a locking seal/tag from the White Earth Natural Resources Department for each pelt or hide of a designated species. This seal/tag must be affixed to the hide or pelt through an eye or some other manner as described by the Natural Resources Department.

Subd.3) Pelts of fur bearing animals must be registered with the White Earth Natural Resources Department if possessed more than five (5) days after the close of the respective season.

Subd.4) Wanton waste of fur bearing animals is prohibited. All traps must be tended at least once every 72 hours.

Subd.5) It is prohibited to tend the traps of any permitted trapper other than those for which the person has written permission. If a person obtains written permission to tend another's traps, he/she must possess the valid unexpired Tribal Identification Cards, and valid Natural Resources Harvest Permits of the original trapper and the tender as well as a written permission slip from the owner of the traps.

Subd.6) All traps and snares must be clearly marked with the owner's identification tag number.

Subd.7) When trapping by snare, the top of the snare must be firmly located no higher than 16 inches from the top of the ground, or firmly compacted snow. Such snare may not be more than 10 inches in diameter.

Subd.8) It is prohibited to set, place, or operate body gripping or conibear type traps that have a maximum jaw opening, when set, of greater than 7-1/2 inches, excepting when the trap is at least half submerged in a lake, river, creek, or pond.

Subd.9) All traps shall be concealed to prevent trapping protected animals such as, eagles, owls, etc. Any protected animal, or threatened/endangered species accidentally caught in the trap must be turned over to the White Earth Conservation Department immediately.

Subd.10) Trapping permits on the Tamarac National Wildlife Refuge are restricted to enrolled members of the White Earth Band of Chippewa Indians who are at least 16 years of age.

Subd.11) The use of dogs while bobcat hunting will be permitted while the hunter is on foot and in the possession of a rifle or hand gun meeting the requirements of **C.C. 304.00 Firearms/Bow/Crossbow Regulations** or shotguns with shot ammunition.

Subd.12) Rules and regulations noted in **C.C. 304.01 Concealed Carry and/or Permits to Carry** will be followed.

C.C. 400.00 Wild Rice Provisions

C.C. 401.00 Wild Rice Permits

Subd.1) All persons 16 years of age or older who take wild rice must have in his/her possession and on his/her person, a valid unexpired Tribal Identification Card, a valid Natural Resources Harvest Permit, and follow seasons, rules, and regulations under this Code.

C.C. 402.00 Wild Rice Rules and Regulations

Subd.1) It is prohibited to take wild rice by any means except with:

- a) A hand flail no longer than 30 inches and weight no more than one pound;
- b) A canoe no more than 18 feet in length and less than 42" inches in width;
- c) A push pole that has forks 12 inches or less;
- d) Or on foot;

within seasons, hours, and methods as established by the White Earth Tribal Council or the Director of Natural Resources.

Subd.2) It is prohibited for anyone, except enrolled White Earth Band members, to harvest wild rice on Lower Rice Lake in Clearwater County.

Subd.3) It is prohibited to wantonly waste or destroy wild rice. Overabundance of wild rice plant stalks and/or heads in the gathering process will be considered destruction of the plant.

Subd.4) To destroy aquatic life is prohibited. Overabundance of wild rice plant stalks and/or heads in the gathering process will be considered destruction of the plant

Subd.5) The possession, use and transportation of firearms will be in accordance with applicable Federal, State and Reservation regulations.

Subd.6) All landing areas shall be kept neat and orderly. No littering.

Subd.7) Disturbance of peace or any other disorderly conduct is prohibited.

Subd.8) It is prohibited to take wild rice by mechanical means within the exterior boundaries of the White Earth Indian Reservation.

Subd.9) The harvesting of unripe, green wild rice is strictly prohibited.

Subd.10) Testing any body of water for the ripeness of the wild rice crop before the season has been established, will be done with permission from the White Earth Director of Natural Resources.

Subd.11) While testing, any boat with more than 20 pounds of wild rice in it is prohibited and will be considered harvesting green rice and/or harvesting ripe rice out of season.

Subd.12) It is prohibited to own and/or operate a Commercial Paddy Rice operation within the White Earth Reservation boundaries.

C.C. 403.00 Genetically Modified Wild Rice

Subd.1) It is prohibited to own or operate a genetically modified wild rice facility without prior approval from the White Earth Reservation Tribal Council.

Subd.2) It is prohibited to introduce, grow, or plant any type of genetically modified wild rice on land or water within the exterior boundaries of the White Earth Indian Reservation. See Subd.40), **C.C. 101 Definitions**

WHITE EARTH RESERVATION BUSINESS COMMITTEE
WHITE EARTH BAND OF CHIPPEWA INDIANS
Resolution No. 057-24-023A

- WHEREAS,** the White Earth Reservation Business Committee is the duly elected governing body of the White Earth Reservation pursuant to Article IV, Section I, of the revised constitution and bylaws of the Minnesota Chippewa Tribe, as amended, and organized under Section 16, of the Act of June 18, 1934 (48 Stat. 984), and
- WHEREAS,** the White Earth Reservation Business Committee "RBC" is the duly authorized governing body of the White Earth Band, and
- WHEREAS,** the RBC has previously enacted the White Earth Reservation Conservation Code "W.E.C.C.", Resolution No. 057-09-005, for the protection, management, restoration, enforcement, and enhancement natural resources within the exterior boundaries of the White Earth Reservation, and
- WHEREAS,** the RBC finalized a Memorandum of Agreement "MOA" with the United States by and through the United States Fish and Wildlife Service "USFWS" for the area known as the Tamarac National Wildlife Refuge "Refuge" on June 4, 2024, and
- WHEREAS,** the Refuge's land and waters are located within the exterior boundaries of the White Earth Reservation and adjoining lands where White Earth Tribal members exercise hunting, fishing, and gathering rights that are fundamental to the identity, health, welfare, and economic well-being of the White Earth Band and tribal members, and
- WHEREAS,** consistent with the aforementioned MOA and Resolution No. 057-24-023 the RBC amends the W.E.C.C. to replace the former Tamarac National Wildlife Refuge Chapter with the Tamarac National Wildlife Refuge Ordinance to improve natural resource protections and procedures for Band member permits within the Refuge, now

THEREFORE BE IT RESOLVED, the White Earth RBC amends the W.E.C.C. to replace the former Tamarac National Wildlife Refuge Chapter with the new Tamarac National Wildlife Refuge Ordinance as follows.

We do hereby certify that the foregoing resolution was adopted by a vote of 3 for, 0 against, 0 silent, a quorum being present at a regular meeting of the White Earth Reservation Business Committee held on June 28, 2024 in Mahabon Minnesota.

Michael A. Fairbanks, Chairman

Michael LaRoque, Secretary/Treasurer

C.C. 500.00 Tamarac National Wildlife Refuge Ordinance

General Provisions

C.C. § 500.01 Short Title

This Section of the White Earth Conservation Code (W.E.C.C.) shall be entitled “Tamarac National Wildlife Refuge Ordinance,” and may be abbreviated as the W.E.C.C. Tamarac Refuge Ordinance.

C.C. § 500.02 Repeal and Replace

1. This ordinance replaces and repeals the former White Earth Conservation Code Chapter 500 titled the Tamarac National Wildlife Refuge Provisions with this new Chapter 500 Tamarac National Wildlife Refuge Ordinance.
2. Enactment of this Ordinance does not void any prior Court order made in reliance on the former version(s) of the Code.

C.C. § 500.03 Conflict with other Tribal Laws

If any provisions of the W.E.C.C. Tamarac Refuge Ordinance conflict with other provisions in the laws of the White Earth Band of Ojibwe, the provisions of this Ordinance shall supersede such other provisions with the exception of the White Earth Judicial Code.

C.C. § 500.04 Declaration of Policy

1. White Earth Tribal Council, also known as the Reservation Business Committee (RBC), recognizes the special and unique nature of the Tamarac National Wildlife Refuge (herein Refuge), and that the Refuge has certain protections under Federal law.
2. White Earth RBC enacted this ordinance for the preservation and protection of tribal members’ inherent and retained rights within the Refuge, and for the protection and enhancement of the Refuge’s natural resources for future generations by establishing standards and regulations for permitting Band member activities within the entirety of the Refuge which allow maximum usage while maintaining populations at a level of regeneration.
3. The Seven Ojibwe principles that guide decisions pursuant to this Ordinance are:
 - a. Gwayakwaadiziwin, honesty;
 - b. Zaagi’idiwin, compassionate love;
 - c. Aakode’ewin, courage;
 - d. Debwewin, truth;
 - e. Nibwaakaawin, wisdom;
 - f. Dabaadendiziwin, humility;
 - g. Minaadendamowin, respect.

C.C. § 500.05 Purpose of the Ordinance

1. The purpose of this Ordinance is to establish standards and a process for permitting:
 - a. White Earth Band members' rights to various activities within the Refuge including ceremonies, leeching, turtling, minnowing, furbearer trapping, gathering, ricing, and wood cutting activities, and
 - b. permitting research activities within the entirety of the Refuge for any research that uses material the Tribe has a claim of ownership to, pursuant to White Earth Nation's Research Code enacted by Resolution No. 001-17-008.

C.C. § 500.06 Applicability and Scope

1. The Ordinance shall apply to all permitted activities conducted by White Earth Band members within the Refuge contained within this Ordinance.
2. The White Earth RBC recognizes the unique nature of law enforcement and natural resource management responsibilities that White Earth Department of Natural Resources (herein WEDNR) is tasked with. The WEDNR has a duty to protect and manage natural resources of the Reservation as well as Band members' rights to access resources within the entirety of the Refuge such that WEDNR is authorized to issue permits under this Ordinance, implement, and enforce provisions of this Ordinance subject to the direction and oversight of the White Earth RBC.

C.C. § 500.07 Authority and Sovereign Immunity

1. White Earth Reservation Tribal Council, as the duly elected governing body of the White Earth Band of Ojibwe enacts this Ordinance pursuant to inherent sovereign authority and in accordance with Article IV, Section I, of the revised Constitution and Bylaws of the Minnesota Chippewa Tribe, as amended, and organized under Section 16, of the Act of June 18, 1934 (48 Stat. 984).
2. Nothing contained in this Ordinance shall be deemed or construed as a waiver, limitation, or modification of the White Earth Reservation's sovereign immunity, and such sovereign immunity is expressly asserted in any action required for the enforcement of this Ordinance.

C.C. § 500.08 Effective Date

This Ordinance shall take effect immediately upon approval by the White Earth Reservation Business Committee.

C.C. § 500.09 Severability

If any part of this Ordinance is invalidated, the remainder shall remain in effect.

C.C. § 500.10 Definitions

For purposes of this ordinance, White Earth Conservation Code (W.E.C.C.) Chapter 101 Subd. 1 – 95, applies with respect to definitions used in this ordinance. Relevant and additional definitions as used in this Ordinance are as follows.

1. Administrative facilities: buildings, structures, or monuments within the Refuge, including office buildings, kiosks, boat landings, and pit toilets.
2. Alternative permittee/drawing winner: Must be at least 16 years of age or older, in good standing, and an enrolled member of the White Earth Band who is selected at a drawing to take over the permitted activity in the event the original drawing winner and harvest partners are unable to.
3. Apprentice: also known as mentored youth, enrolled persons or persons eligible for enrollment in White Earth Band under 16 years of age accompanied by an adult who assumes responsibility of the minor for the purpose of learning a permitted activity on the Refuge.
4. As Is: the existing condition of an area.
5. Authorized Activity: also referred to as permitted activity, regulated conduct through a permit issued in accordance with sections contained in this Ordinance.
6. Aquatic Invasive Species: a non-native animal, plant, or other organism that lives primarily in water and is either causing harm or has the potential to cause harm in an area beyond the organism's native range.
7. Bait: see W.E.C.C. 101 Subd. 9.
8. Bait fish: see W.E.C.C. 101 Subd. 10.
9. Band Member: shall mean a person who is enrolled in the White Earth Nation.
10. Ceremonial Use Permit: shall mean a permit to conduct a ceremony within Refuge boundaries that is issued by the White Earth Licensing Department only to enrolled members of the White Earth Band. Ceremonial Use permits shall denote the permittee's name, date of birth, enrollment number, current contact information; location of the ceremony, duration, and approximate number of participants. See Section 501, intra.
11. Closed Area: a delineated location in the Refuge permanently or seasonally closed to permitted activities.
12. Commercial Leech and Minnow License: see W.E.C.C. Section 1000. Permit for commercial purposes for leeching, minnowing, and turtling.
13. Commercial purposes: see W.E.C.C. 101 Subd. 23. Note for leeching and minnowing on the Refuge, commercial purposes are considered harvesting more than 144 individual leeches or minnows and requires a commercial license. See intra Section 505.01 and W.E.C.C. Section 1000 for more information.

14. Conservation Officer: see W.E.C.C. Section 101 Subd. 24.
15. Contempt list: a list of persons with suspensions or permanent loss of eligibility for various permitted activities on the Refuge maintained by WEDNR or authorized representative.
16. Daily limit: see W.E.C.C. 101 Subd. 26.
17. Dead and downed: trees or broken limbs that have fallen to the ground without human intervention.
18. Designated zone: a determined area that delineates the location in which a permitted activity may occur on the Refuge.
19. Drawing Winner: the permittee who wins a lottery drawing for access to a certain designated zone or selected location within the Refuge for a particular permitted activity.
20. Fur bearing animal: see W.E.C.C. 101 Subd. 37.
21. Game animal: see W.E.C.C. 101 Subd. 38.
22. Game Fish: see W.E.C.C. 101 Subd. 39.
23. Good cause: substantial and generally unforeseen circumstances beyond a person's control that significantly impact that person.
24. Good standing: as used in this ordinance means eligible for permitted activity because the person's eligibility is not suspended or otherwise found to be in violation of this ordinance, W.E.C.C. or other applicable laws.
25. Guardian: see W.E.C.C. Section 101 Subd. 41.
26. Harvest partner: Also known as helper or associate. Must be 16 years of age or older, in good standing, and have a valid Tribal identification card from the White Earth Band. No more than two persons may be designated as harvest partners for leeching/turtling, minnowing, and furbearer trapping.
27. Mushroom: the fruiting portion of fungal growth.
28. Nut: a fruit consisting of a hard shell protecting a usually edible kernel.
29. Natural Resources: see W.E.C.C. Section 101 Subd. 52.
30. Non-game/rough fish: see W.E.C.C. Section 101 Subd. 55.
31. Nontimber Forest products: includes any product other than timber that is naturally produced in forested biomes and can be harvested for human use without cutting down trees.

32. Permitted activity: also referred to as authorized activity, regulated conduct through a permit issued in accordance with sections contained in this Ordinance.
33. Personal use: see W.E.C.C. Section 101 Subd. 66, includes all uses other than commercial including ceremonial, educational, and research.
34. Permittee: the person who through a permit or, if applicable a drawing, has been authorized to carry out a specified activity within the Refuge.
35. Research Activity: the definition contained in 05A of White Earth Nation Research Code: the use of systematic methods to gather and analyze information for the purpose of proving or disproving a hypothesis, evaluating concepts or parties or otherwise adding to knowledge and insight in a particular discipline or field of knowledge or to demonstrate or investigate theories, techniques, or practices, including (1) basic and clinical research; (2) behavioral studies; (3) anthropological and archaeological studies; or (4) feasibility and other studies designed to evaluate or test programmatic techniques or to develop basic data in all phases of public administration.
36. Research Natural Area: an area in the Refuge that contains important ecological and scientific values and is managed for minimum human disturbance apart from education and research under federal law, 43 U.S.C. § 8223 et seq.
37. Reservation: see W.E.C.C. Section 101 Subd. 72.
38. Ricing: see W.E.C.C. Section 101 Subd. 73.
39. Slash: unused parts of the tree when cutting firewood such as the limbs and tops.
40. Small game animals: see W.E.C.C. Section 101 Subd. 77.
41. Special waiver permit: intra Section 500.11 Subd. 4 and 5, upon showing of good cause Band members may be eligible for waiver permit to a permitted activity provided they follow notice requirements contained in Section 500.11.
42. Substitute drawing winner: an eligible harvest partner who assumes a drawing winner's activity when the drawing winner is unable or unwilling to participate in the activity. Must be at least 16 years of age or older, in good standing, and an enrolled member of the White Earth Band. WEDNR reserves the right to deny such selections.
43. Take or taking: see W.E.C.C. Section 101 Subd. 83.
44. Tamarac National Wildlife Refuge Harvest Permit: (herein abbreviated as Refuge Harvest Permit) permits issued to eligible White Earth Band enrolled members. The Permit and attachments shall denote what natural resource activity is covered; permittee's: name, date of birth, current contact information, enrollment number; the location or designated zone of the activity; the duration of the activity; and approximate quantity of the targeted resources as well as other relevant information requested by WEDNR.

45. Waterfowl: see W.E.C.C. Section 101 Subd. 89.
46. White Earth Band: means the White Earth Band of Ojibwe or Minnesota Chippewa Tribes also referred to as White Earth Nation.
47. White Earth Licensing Department: also known as the White Earth Department of Motor Vehicles (DMV) is the Department responsible for issuing permits under this Ordinance.
48. White Earth Division of Natural Resources (WEDNR): also known as White Earth Natural Resources Department, is the Division of White Earth Nation's government tasked with the responsibility to protect, manage, and enhance the White Earth Nation's natural resources and environment by efficient and effective ways to allow maximum usage while maintaining population at a level capable of regeneration.
49. White Earth Reservation Business Committee (RBC): is the governing body of the White Earth Band of Ojibwe incorporated into the Minnesota Chippewa Tribe through the revised constitution and bylaws enacted pursuant to Section 16 of the Indian Reorganization Act of 1934.
50. White Earth Research Review Board (RRB): a members consisting of a Board instituted pursuant to Resolution No. 001-17-008 to implement the White Earth Nation Research Code.
51. Wilderness Area: protected and defined under federal law in the Wilderness Act, codified as 16 U.S.C. § 1131 et seq.
52. Wood cutting permit: a permit obtained from WEDNR Forestry Division for personal use only to collect dead and down wood in the Refuge.

C.C. § 500.11 General Information and Provisions for Activities on the Refuge

1. Permitted activities may occur only during Refuge open hours from 5 a.m. to 10 p.m. daily unless otherwise authorized by permit.
2. All persons carrying out authorized activities in the Refuge that require access through combination lock systems on gates must return such locks to a closed and locked position when both entering and exiting Refuge trails.
3. Combination locks must be interlocked between the Refuge lock and another use lock or one end of the chain in a manner that allows independent entry by permitted parties and prohibits entry by unauthorized persons. Failure to do so shall result in penalties. Persons are required to report missing locks or vandalism as soon as practicable upon discovery.
4. Enrolled Band members may be eligible for a waiver to general regulations for a permitted activity through a special waiver permit upon a showing of good cause or a request based upon that member's different abilities or disabilities which necessitate a waiver. Persons requesting a special waiver permit must contact WEDNR at least 48 hours in advance. WEDNR shall endeavor to make reasonable accommodations when good cause or ability necessitates a waiver. WEDNR reserves the right to deny

such requests when in conflict with cultural understandings, federal or White Earth Tribal laws, natural resource management practices or if no reasonable accommodations can be made. WEDNR agrees to inform USFWS Refuge Manager when a special permit is requested and shall give due consideration to any recommendations or concerns.

5. Harvest partners may be changed during the season when the permittee/drawing winner immediately informs WEDNR of the change and provides proof the new harvest partner is eligible. WEDNR reserves the right to deny such changes.
6. When a drawing winner is unable to participate in the particular activity they won, that winner may choose one harvest partner as their alternative permittee. WEDNR reserves the right to deny such selections.

C.C. § 500.12 Prohibited, Unlawful, or Restricted Acts on the Refuge

All prohibited acts contained in W.E.C.C. Section 102.00 Subd.1-17 General Provisions and Prohibited Acts, applies within the Refuge to permitted activities. Each permitted activity may have additional restrictions, refer to the specific activity's section. Refuge specific prohibitions and restrictions are as follows:

1. It is prohibited to litter, leave garbage, or personal property in the Refuge past 10 p.m. each day of the duration of the permit.
2. There is a limited exception for leaving personal property when it is equipment related to an authorized activity such as canoes or person propelled boats, harvesting equipment, or ceremonial structures for the pendency of the activity. Such personal property must be removed by 10 p.m. on the expiration date of the permit. Persons who choose to leave their property during the pendency of a permitted activity assume all liability and do not hold USFWS or WEDNR responsible for any theft or damage as a result.
3. Storing bait or any personal property in a manner likely to entice wildlife and create a nuisance or pose a risk to public safety is prohibited.
4. Unattended traps create a presumption of endangering others life and property.
5. Licensed automobiles are permitted only on open designated trails and roads.
6. Bicycles are permitted only on county and township roads, Bruce Boulevard and the Blackbird Wildlife Drive.
7. Horses are only permitted on county and township roads.
8. The use of snowmobiles is strictly prohibited.
9. Licensed Off-Road Recreational Vehicles (ORRV), Off-Road Vehicles (ORV) and Off Highway Vehicles (OHV) are permitted on County and Township roads only. Operation of ORRV, ORV or OHV on Refuge roads including administrative trails, Bruce Boulevard and Blackbird Wildlife Drive is strictly prohibited without written permission.

10. Open fires are prohibited unless authorized by permit.
11. Parking, blocking or in any manner restricting access to roads, boat landings and gates is prohibited.
12. Camping and overnight parking is prohibited unless authorized by permit.
13. Personal motorized watercraft, swimming, waterskiing, and tubing are prohibited on all Refuge waters.
14. Outboard motors are prohibited on all Refuge waters except those open to fishing and migratory bird hunting. On Blackbird Lake only electric motors are allowed for fishing.
15. All motorized vehicles are prohibited on the ice.
16. A valid Minnesota state permit to carry, or permit to carry from another jurisdiction that Minnesota has reciprocity with, is required to carry firearms outside of established hunting seasons except as otherwise prohibited by applicable Federal law.
17. Target, skeet, trap and indiscriminate shooting is prohibited.
18. Trapping activities have special regulations regarding firearms, see intra Sections 506.
19. Pets must be kept on a leash or under voice control at all times.
20. Damage or destruction of Refuge habitats and vegetation is strictly prohibited unless incidental to a permitted activity in which the permittee may be required to demonstrate reasonable efforts were taken to minimize damage.
21. Exceptions to the above restrictions and prohibitions may apply in individual activity sections or with written permission from the WEDNR and/or Refuge manager.

C.C. § 500.13 Inspection and Enforcement Procedures

1. White Earth Conservation Law Enforcement Officers may inspect any permitted activity in the Refuge for compliance with relevant regulations and applicable laws.
2. Consistent with the current Memorandum of Understanding between United States Fish and Wildlife Service Tamarac National Wildlife Refuge and White Earth Nation Reservation Tribal Council in effect:
 - a. USFWS agrees that USFWS Law Enforcement Officers who contact White Earth tribal members in the Refuge found suspected violation of any provision of the W.E.C.C. Tamarac Refuge Ordinance shall report such to White Earth Conservation Law Enforcement for further investigation, and
 - b. USFWS Law Enforcement Officers may inspect any regulated activity in the Refuge for compliance with Federal Laws. In the sensitive case of ceremonial activities, USFWS Law Enforcement Officers shall, to the greatest extent practicable, be accompanied by White Earth Conservation Law Enforcement Officers.

- c. For further information related to enforcement procedures, refer to the above referenced Memorandum of Understanding.
3. USFWS Law Enforcement Officers, White Earth Conservation Law Enforcement Officers, and State of Minnesota Law Enforcement Officers may take all necessary action(s) in response to suspected criminal activity within the Refuge.
4. WEDNR, White Earth Conservation Law Enforcement Officers, the Cultural Division, WERRB, or other authorized representative of tribal government may initiate proceedings in Tribal Court to enforce this ordinance.

C.C. § 500.14 Penalties

1. All persons are required to comply with relevant federal laws and regulations while in the Refuge including but not limited to: the Migratory Bird Treaty Act, Eagle Protection Act, Lacey Act, National Wildlife Refuge System Administration Act, National Wilderness Act, National Wildlife Refuge System Administration Act and National Wildlife Refuge System Improvement Act. Violations of federal laws and regulations may result in legal action in federal and/or tribal court.
2. When circumstances require an immediate response for serious infractions and violations of applicable laws White Earth Conservation Law Enforcement Officers may seize permits under the direction of the WEDNR Director. White Earth members whose permits are seized in this manner may petition WEDNR Director for reinstatement. Any decisions by the WEDNR Director with regard to the seizure and reinstatement of a permit under this Ordinance is final.
3. Any violations of the White Earth Tribal Codes, White Earth Conservation Code, this Ordinance, and permit's conditions or attachments may result in the revocation of the permit, suspension of eligibility for future permits and drawings, fines, other civil, and/or criminal penalties in Tribal Court.
4. Civil remedies in Tribal Court may include but are not limited to injunctive relief, seizure and forfeiture, posting of bonds or sureties to ensure compliance with tribal law.
5. Civil penalties include but are not limited to: fines of \$5,000 for each found violation, suspended permit privileges for a minimum of 3 years not to exceed 5 years for each found violation.
 - a. A Tribal Court finding of serious, repeated, reckless, or intentional violations shall result in a permanent suspension from activities within the Refuge and may result in fines not less than \$5,000 nor more than \$15,000 for each violation.
6. Criminal penalties include but are not limited to: jail time not to exceed 180 days.
7. WEDNR or authorized representative shall maintain a contempt list of persons with suspensions or permanent loss of eligibility and share such list with relevant divisions and departments of White Earth Nation.

C.C. 501.00 Ceremonial Use Regulations

C.C. § 501.01 Ceremonial Use Refuge Permits

1. There must be an enrolled White Earth member designated as the permittee for a ceremonial use permit to conduct or engage in a cultural, traditional, religious, or spiritual ceremony with the accompanying regulations and privileges on the Refuge contained herein.
2. Persons must be at least 16 years of age, in good standing, and possess a valid, unexpired White Earth Tribal Identification card to be eligible as a permittee for a ceremonial use permit.
3. White Earth Licensing Department shall issue Ceremonial Use Refuge permits.
4. Ceremonial use permits are nontransferable.
5. Permittee is responsible for all ceremony participants in the Refuge for the duration of permitted activity.
6. Ceremonial use permit partners, apprentices, and participants do not need to be enrolled members of the White Earth Band to participate or engage in the permitted activity. Through their participation in the activity, non-enrolled persons thereby enter a consensual relationship with the White Earth Band and agree to submit to the jurisdiction and authority of White Earth Tribal laws and White Earth Tribal Court.

C.C. § 501.02 Ceremonial Use Regulations

1. Disturbance of the peace, disorderly conduct, or otherwise disrespectful behavior is strictly prohibited.
2. Constructed ceremonial structures, to the greatest extent practicable, shall use only biodegradable materials and shall not be permanent.
3. Any structure, personal property, or offsite materials with the exception of spiritual offerings must be removed by 10 p.m. on the expiration date of the permit.
4. Ceremonial use permits are the only exception to fire prohibition in the Refuge. The use of fire is weather and condition dependent. Fire is prohibited when under unsafe wildfire conditions or burn bans. It is the responsibility of the permittee to know when these unsafe fire conditions are prevalent.
5. Transporting wood sourced off the Refuge is prohibited. Therefore the use of fire must also have a dead & down wood cutting permit endorsement for this purpose, see intra Section 502.
6. Ceremonies requiring gathering of plants and other nontimber forest products must also have a permit endorsement for this purpose, see intra Section 503.
7. Ceremonies requiring traditional timber forest products must also have a permit endorsement for this purpose, see intra Section 504.
8. The permittee must be present and have on his or her possession the ceremonial use permit for the permitted duration of the activity.

9. The permittee and all participants accept the condition of the premise “as is” and agree to leave the premises in as good a condition as when they arrived except for reasonable wear and tear and/or leaving spiritual offering.
10. In the case of damages, the permittee is responsible to repay the Refuge or relevant party any and all damages as a direct or indirect result of his or her negligence or failure to act with care, and that of the ceremony participants.
11. Permittees shall take all reasonable precautions to prevent the escape of fires, suppress fires and render all reasonable assistance in the suppression of Refuge fires.
12. Permittees and participants shall take all reasonable precautions to prevent nuisance wildlife by exercising due care when handling materials that are commonly known to attract wildlife.
13. A ceremonial use permit does authorize the permittee to restrict unauthorized persons from entry into the ceremonial use permitted area. However the ceremonial use permit does not grant the permittee the ability to restrict authorized entry in his or her permitted area for lawful purposes such as law enforcement or emergency services.
14. WEDNR and the Cultural Division reserves the right to revoke any ceremonial use permit for noncompliance with applicable laws and regulations. WEDNR may also revoke a ceremonial use permit for nonuse.
15. Permittees and ceremony participants agree to hold the White Earth Licensing Department, WEDNR, the Cultural Division, and USFWS harmless for any and all claims for damages or losses that may arise in the use of the ceremony permit. Permittees and ceremony participants understand and accept the inherent risks involved in wild spaces.
16. Any personal property that remains 30 days after the termination of the permit’s expiration date shall become WEDNR or USFWS property. The failure to remove personal property may result in civil or criminal penalties.
17. Other conditions and regulations may apply. Permittees shall refer to the permit and its attachments or contact WEDNR for more information and questions.

C.C. 502.00 Dead & Down Woodcutting Regulations

C.C. § 502.01 Dead & Down Woodcutting Permits

1. Dead & down wood cutting permits are required for all wood cutting related activities including firewood.
2. Dead & down wood cutting permits are nontransferable.

3. A valid, unexpired Tribal Identification card, good standing, and a dead & down wood cutting permit from White Earth Licensing Department are required to participate in the collection of dead and down timber wood cutting activity on the Refuge.
4. WEDNR Forestry Department may provide additional regulations and management decisions related to wood cutting activities in the Refuge as needed. Contact WEDNR Forestry Division for more information.
5. Permittees shall provide their name and contact information.

C.C. § 502.02 Dead & Down Woodcutting Regulations

1. Dead and down wood cutting is limited to five (5) cords per permittee per season but permittees may be eligible for additional permits upon request. Season dates are September 1st to March 1st annually.
2. Only dead and down wood may be harvested along designated roads and trails on the Refuge open to automobile access. Dead and down wood may be cut within 100 feet of the centerline of the road or trail.
3. Live vegetation shall not be cut to create access.
4. Unused portions of wood (slash) must be removed from roads and ditches. Slash shall be further cut and scattered so that wood lies no more than 12 inches from the ground to assist in the prevention of wildfire.
5. Any form of woodcutting may not occur in Closed areas, Wildlife Drive, Wilderness Areas, or Research Natural areas on the Refuge.
6. Woodcutting is prohibited within 100 feet of moving water, 50 feet of standing water, and 100 feet of administrative facilities without prior written permission from WEDNR and USFWS.
7. Any power equipment used to aid in wood cutting activities shall be in good repair with a screen-type spark-arrester of .023 inches or less and qualified under federal standards.
8. Fuel for any power equipment shall be properly stored in a vehicle.
9. When a fire risk is anything greater than “low,” permittees must carry a fire extinguisher and shovel with them while harvesting.
10. Permittees shall take all reasonable precautions to prevent the escape of fires, suppress fires and render all reasonable assistance in the suppression of refuge fires.
11. Permittee accepts the condition of the premise “as is” and agree to leave the premises in as good a condition as when they arrived except for reasonable wear and tear.

12. In the case of damages, each permittee is responsible to repay the Refuge or relevant party any and all damages as a direct or indirect result of his or her negligence or failure to act with care, and that of his or her apprentices.
13. Permittees shall take all reasonable precautions to prevent nuisance wildlife by exercising due care when handling materials that are commonly known to attract wildlife.
14. A wood cutting permit does not grant the ability to restrict other authorized entry in his or her permitted area.
15. WEDNR reserves the right to revoke any Refuge harvest permit for noncompliance with applicable laws and regulations. WEDNR may also revoke a Refuge harvest permit for nonuse.
16. Permittees agree to hold White Earth Licensing Department, WEDNR, and USFWS harmless for any and all claims for damages or losses that may arise in the use of the Refuge harvest permit. Permittees understand and accept the inherent risks involved in wild spaces.
17. Any personal property that remains 30 days after the termination of the permit's expiration date shall become WEDNR or USFWS property. The failure to remove personal property may result in civil or criminal penalties.
18. Other conditions and regulations may apply. Permittees shall refer to the permit and its attachments or contact WEDNR for more information and questions.

C.C. 503.00 Gathering Nontimber Forest Products on the Refuge

§ 503.01 Nontimber Forest Products Permits

1. Good standing, a valid, unexpired Tribal Identification card and a Refuge harvest permit from White Earth Licensing Department is required to participate in gathering nontimber forest products from the Refuge including but not limited to mushrooms, nuts, and berries, as well as other species used for healing, ceremony, educational, and other traditional purposes.
2. Permittee agrees to support WEDNR's mission and upon request by WEDNR Director, or a person authorized by the Director, shall provide a list of plant species and approximate quantities gathered. If requested by WEDNR the failure to provide such information may result in a loss of eligibility for future participation in activities.
3. Refuge Harvest permits are nontransferable.

C.C. § 503.02 Nontimber Forest Products Regulations

1. The harvest or gathering of nontimber forest products are for personal or ceremonial use only. Limits on quantity and type of species for the harvest of nontimber forest products are under the discretion of the WEDNR Forestry Division and will be attached to the Refuge Harvest permit when necessary.

2. Any harvest of rare or protected plant or fungi species under federal, tribal, and state law is strictly prohibited. Permittees shall refer to the permit attachment for species unavailable for harvest. It is the responsibility of the permittee to know which species are protected by law.
3. Harvesting plants and fungi species within 100 ft of administrative facilities is prohibited.
4. Permittees and apprentices shall use reasonable care and take precautions not to damage other non-target species. The damage or removal of vegetation to facilitate harvest is prohibited.
5. The permittee accepts the condition of the premise “as is” and agree to leave the premises in as good a condition as when they arrived except for reasonable wear and tear.
6. In the case of damages, the permittee is responsible to repay the Refuge or relevant party any and all damages as a direct or indirect result of his or her negligence or failure to act with care, and that of his or her apprentices.
7. Permittees shall take all reasonable precautions to prevent fires, suppress fires and render all reasonable assistance in the suppression of refuge fires.
8. Permittees and apprentices shall take all reasonable precautions to prevent nuisance wildlife by exercising due care when handling materials that are commonly known to attract wildlife.
9. A Refuge Harvest Permit does not grant the ability to restrict other authorized entry in his or her permitted area.
10. WEDNR reserves the right to revoke any Refuge Harvest Permit for noncompliance with applicable laws and regulations. WEDNR may also revoke a Refuge harvest permit for nonuse.
11. Permittees agree to hold White Earth Licensing Department, WEDNR, and USFWS harmless for any and all claims for damages or losses that may arise in the use of the Refuge harvest permit. Permittees understand and accept the inherent risks involved in wild spaces.
12. Any personal property that remains 30 days after the termination of the permit’s expiration date shall become WEDNR or USFWS property. The failure to remove personal property may result in civil or criminal penalties.
13. Other conditions and regulations may apply. Permittees shall refer to the permit and its attachments or contact WEDNR for more information and questions.

C.C. 504.00 Gathering Traditional Timber Forest Products on the Refuge

C.C. § 504.01 Traditional Timber Forest Products Permits

1. Good standing, a valid, unexpired Tribal Identification card and a Refuge harvest permit from White Earth Licensing Department is required to participate in gathering traditional timber forest products from the Refuge including but not limited to diamond willow, black ash, tamarack, birch bark, snake

sticks, collection of timber materials for ricing poles or lodges, and other timber products traditionally used for healing, ceremony, educational, and other traditional purposes.

2. Permittee agrees to support WEDNR's mission and upon request by WEDNR Director, or a person authorized by the Director, shall provide a list of tree species and approximate quantities gathered. If requested by WEDNR the failure to provide such information may result in a loss of eligibility for future participation in activities.
3. Refuge Harvest permits are nontransferable.

C.C. § 504.02 Traditional Timber Forest Products Regulations

1. The harvest of traditional timber forest products is for personal use only. WEDNR Forestry Division determines quantities and when necessary shall attach a list to the Refuge Harvest permit.
2. Any harvest of rare or protected tree species under federal, tribal, and state law is strictly prohibited. It is the responsibility of the permittee to know which species are protected by law.
3. Permittees and apprentices shall use reasonable care and take precautions not to damage other non-target species. The damage or removal of vegetation to facilitate harvest is prohibited.
4. Permittees and apprentices are expected to use best management practices in the removal of targeted species by using respectful and careful harvesting procedures.
5. The permittee accepts the condition of the premise "as is" and agree to leave the premises in as good a condition as when they arrived except for reasonable wear and tear.
6. Any form of woodcutting may not occur in Closed areas, Wildlife Drive, Wilderness Areas, or Research Natural areas on the Refuge.
7. Woodcutting is prohibited within 100 feet of moving water, 50 feet of standing water, and 100 feet of administrative facilities without prior written permission from WEDNR and USFWS.
8. Any power equipment used to aid in wood cutting activities shall be in good repair with a screen-type spark-arrester of .023 inches or less and qualified under federal standards.
9. Fuel for any power equipment shall be properly stored in a vehicle.
10. When a fire risk is anything greater than "low," permittees must carry a fire extinguisher and shovel with them while harvesting.
11. Permittees shall take all reasonable precautions to prevent fires, suppress fires and render all reasonable assistance in the suppression of refuge fires.
12. Permittees and apprentices shall take all reasonable precautions to prevent nuisance wildlife by exercising due care when handling materials that are commonly known to attract wildlife.

13. A Refuge Harvest Permit does not grant the ability to restrict other authorized entry in his or her permitted area.
14. WEDNR reserves the right to revoke any Refuge Harvest Permit for noncompliance with applicable laws and regulations. WEDNR may also revoke a Refuge harvest permit for nonuse.
15. In the case of damages, the permittee is responsible to repay the Refuge or relevant party any and all damages as a direct or indirect result of his or her negligence or failure to act with care, and that of his or her apprentices.
16. Permittees agree to hold White Earth Licensing Department, WEDNR, and USFWS harmless for any and all claims for damages or losses that may arise in the use of the Refuge harvest permit. Permittees understand and accept the inherent risks involved in wild spaces.
17. Any personal property that remains 30 days after the termination of the permit's expiration date shall become WEDNR or USFWS property. The failure to remove personal property may result in civil or criminal penalties.
18. Other conditions and regulations may apply. Permittees shall refer to the permit and its attachments or contact WEDNR for more information and questions.

C.C. 505.00 Harvesting Leeches, Turtles, and Minnows on Refuge Regulations

C.C. § 505.01 Leech, Turtle, and Minnow Permit Drawing

1. Lottery drawings for leeching, turtling, and minnowing in designated zones or selected locations of Refuge and season dates will be held at the discretion of WEDNR.
2. Permit drawing dates will be set and publicly posted by the WEDNR at least two (2) weeks in advance.
3. All persons must possess a Commercial Leech and Minnow License, be at least 16 years of age, in good standing, and possess a valid unexpired Tribal Identification Card to be eligible for the drawing.
4. Drawing winners will receive a Refuge Harvest permit and should carry this permit on their person during the activity.
5. The drawing winner may select up to two harvest partners to accompany them on the activity.
6. Drawing winner must be present during the activity with the harvest partners unless otherwise approved by WEDNR as detailed in 505.01 Subd. 7.
7. In the event the drawing winner is unable to participate in the activity for the season he/she can select one of their harvest partners to substitute and shall notify WEDNR immediately. WEDNR reserves the right to deny such selections.
8. In the event the original drawing winner and their harvest partners are unable to participate in the activity for the season, an alternative drawing winner will be selected at the drawing.
9. Refuge harvest permits are nontransferable.

10. Minors under 16 years of age may accompany a drawing winner or harvest partner in the Refuge for the purpose of learning how to leech, minnow, or turtle. Apprentices in the Refuge are the responsibility of the adult accompanying them.
11. The permittee/drawing winner must have a Refuge Harvest Permit and Commercial Leech and Minnow License from White Earth Licensing Department, and a valid, unexpired Tribal Identification card in their possession while harvesting leeches, turtles, and minnows in designated zones and selected locations on the Refuge.
12. Harvest partners must have Commercial Leech and Minnow License from White Earth Licensing Department, and a valid, unexpired Tribal Identification card in their possession while harvesting leeches, turtles, and minnows in designated zones and selected locations on the Refuge.
13. Permittees/drawing winners agree to assist WEDNR's mission by reporting approximate numbers of animals taken, location(s), number of traps set, and active date range to a person authorized by the WEDNR each month of the duration of their activity upon request. Failure to provide this information may result in a loss of eligibility for future participation in activities.
14. Drawing winners/permittees and all harvest partners must attend any applicable regulation meetings.
15. Designated zones for harvest and other applicable restrictions are given to drawing winners at the lottery drawing and regulation meetings.

C.C. § 505.02 Leech, Turtle, and/or Minnow Regulations

1. Drawing winners, harvest partners, and apprentices are expected to follow regulations regarding gates in the Refuge, see intra Section 500.11.
2. The introduction of aquatic invasive species is strictly prohibited. Permittees/drawing winners, harvest partners, and apprentices are required to take all necessary precautions to avoid introducing or transporting aquatic invasive species. It is prohibited to use any equipment previously used in known waters with aquatic invasive species infestations.
3. The drawing winner must be present unless otherwise authorized under § 505.01 Subd. 7 when conducting leeching, minnowing, or turtle harvest activities and have on their possession Refuge harvest permit, Commercial Leech and Minnow License, and their valid White Earth Tribal identification card.
4. Turtles shall only be harvested by hand or with handheld equipment.
5. Turtle sizes and daily limits for various turtle species is established by the WEDNR.
6. Snapping turtles must measure at least 10 inches in diameter across the shell's carapace.
7. All leech and minnow traps and any other personal property must be removed from the Refuge by 10 p.m. on the expiration date of the permit.
8. Garbage and bait must be removed each day by 10 p.m. for the pendency of the permitted activity.
9. Littering is strictly prohibited.

10. Permittees, harvest partners, and apprentices agree to remove unused bait each day and are expected to take all reasonable precautions to avoid leaving bait or other substances known to attract wildlife in such a manner as to attract nuisance wildlife and endanger public safety.
11. All unwanted leeches, turtles, and minnows will be immediately returned to the same body of water from which they were taken.
12. All leech and minnow traps must be permanently marked and legible with identification of the permittee's last five digits: of their enrollment number, commercial leech and minnow license number, or Refuge harvest permit. Permittee or drawing winner is responsible to make sure all traps are legible throughout the season.
13. Trap floats shall not use recycled bottles of any sort.
14. Permittee/drawing winner is responsible for all traps and floats in Refuge waters and shall immediately retrieve any loose traps or floats. In the event of missing traps or floats, permittee or drawing winner shall immediately notify WEDNR or USFWS within 24hrs of discovery and take all reasonable steps necessary to locate the missing item.
15. The use of outboard motors for leeching, turtling, and minnowing is only permitted on the following lakes: Blackbird Lake and lakes or wetlands open to migratory bird hunting.
16. Drawing winners and his or her harvest partners and/or apprentices accept the condition of the premise "as is" and agree to leave the premises in as good a condition as when they arrived except for reasonable wear and tear.
17. In the case of damages, the drawing winner is responsible to repay the Refuge or relevant party any and all damages as a direct or indirect result of his or her negligence or failure to act with care, and that of his or her chosen harvest partners and apprentices.
18. Drawing winners shall take all reasonable precautions to prevent fires, suppress fires and render all reasonable assistance in the suppression of refuge fires.
19. Winning a drawing or being a harvest partner or apprentice does not grant the ability to restrict other authorized entry in his or her area.
20. WEDNR reserves the right to revoke a drawing winner for noncompliance with applicable laws and regulations. WEDNR may also revoke a drawing winner for nonuse.
21. Drawing winners and harvest partners agree to hold White Earth Licensing Department, WEDNR, and USFWS harmless for any and all claims for damages or losses that may arise during the activity. Drawing winners and harvest partners understand and accept the inherent risks involved in wild spaces.
22. Any personal property that remains 30 days after the termination of the permit's expiration date shall become WEDNR or USFWS property. The failure to remove personal property may result in civil or criminal penalties.
23. Other conditions and regulations may apply. Permittees and drawing winners shall refer to the permit and its attachments or contact WEDNR for more information.

A. Special Minnow Regulations

1. All regulations in above in Section 505 continue to apply. Minnowing has the following additional regulations.
2. Minnow traps must be either a box or a cylinder style trap made of plastic, galvanized or plastic-coated mesh, or tempered glass designed for river use. Box trap size shall be no greater than 3 feet wide by 3 feet tall by 3 feet long. Cylinder trap size shall be no greater than 24 inches in diameter and 48 inches in length.
3. Maximum of 10 total minnow traps are permitted at each authorized location.
4. Traps at bridge locations on the Ottetail River may be placed up to 200 feet up or downstream.
5. Traps on the Egg River may be placed up to 200 feet downstream and 25 feet upstream to accommodate other upstream uses.
6. All minnow traps must be emptied of fish at least every 72 hours after deployment and as frequently as necessary to prevent losses.
7. WEDNR reserves the right to inspect fishes for disease and promulgate additional regulations as necessary to prevent the spread of disease.

C.C. 506.00 Refuge Furbearer Trapping Regulations

C.C. § 506.01 Trapping Permit Drawing

1. A lottery drawing for fur bearing animal trapping permits in designated zones of Refuge will be held annually. WEDNR shall publicly post the drawing at least two (2) weeks in advance.
2. Available species, limits, and seasons for trapping are determined by WEDNR and approved through RBC Resolution.
3. All persons entering the drawing must be 16 years of age or older, be in good standing, and possess a valid unexpired Tribal Identification Card to be eligible.
4. Each permittee/drawing winner may designate up to two harvest partners and shall provide their names and contact information to WEDNR.
5. The drawing winner/permittee must be present when conducting trapping activities with harvest partners unless otherwise approved by WEDNR in 506.01 Subd. 6.
6. In the event the drawing winner is unable to participate in the activity for the season he/she can select one of their harvest partners to substitute and shall notify WEDNR immediately. WEDNR reserves the right to deny such selections.

7. In the event the original drawing winner and their harvest partners are unable to participate in the activity for the season, an alternative drawing winner will be selected at the drawing.
8. Apprentices may join to learn about trapping activities and are the responsibility of the accompanying adult.
9. Permittees/drawing winners agree to assist WEDNR's mission by reporting approximate numbers of animals taken, location, number of traps or snares set, and date range to a person authorized by the WEDNR Director halfway through the permitted activity (typically around December or January) and again at the conclusion of the activity upon request. Failure to provide this information may result in a loss of eligibility for future participation in activities.

C.C. § 506.02 Trapping Regulations

1. Permittees, harvest partners and apprentices may not possess an archery bow, crossbow, or firearm, other than a .22 caliber rifle used to dispatch trapped species.
2. Any person under 18 years of age who takes furbearers while in possession of a firearm shall also have in his/her possession a valid Federal, State, or Band issued Firearm's Safety Certificate.
3. Permittees must obtain locking seal/tag from WEDNR for each pelt or hide of a designated species. This seal/tag must be affixed to the hide or pelt through an eye or some other manner as prescribed by WEDNR.
4. If a non-target species is able to be released it must be immediately released back into the wild in the same area where it was trapped. If the animal is dead or otherwise cannot be released, you must immediately notify law enforcement officers in the Refuge or the White Earth Tribal Conservation Officers within 24 hours upon discovery and follow their directions regarding the animal.
5. All traps and snares must be clearly marked throughout the season with the last five digits of a permittee's: tribal enrollment number or Refuge Harvest Permit number.
6. Traps and snares must be tended at least every 72 hours. Failure to do so is considered a serious violation and creates a presumption of endangering others life and property.
7. Use of snares for land sets is permitted, with the following special restrictions:
 - a. Cable diameter is limited to not more than 3/32 inches;
 - b. Snare loop size may not exceed 7 inches from top to bottom;
 - c. The bottom of the snare loop may not exceed a height of 8" above the ground.
8. Motorized vehicles including off-road motorize vehicles are not permitted in the Refuge other than the exception that trappers may use motorized vehicles to access trapping zones only on mowed trails.
9. With the exception of trap set materials, no other personnel property including garbage may be left over night on the Refuge.

10. Littering is prohibited.
11. All personal property must be removed by 10 p.m. on the date of expiration for the permit.
12. Drawing winners and his or her harvest partners and/or apprentices accept the condition of the premise “as is” and agree to leave the premises in as good a condition as when they arrived except for reasonable wear and tear.
13. In the case of damages, the drawing winner is responsible to repay the Refuge or relevant party any and all damages as a direct or indirect result of his or her negligence or failure to act with care, and that of his or her chosen harvest partners and apprentices.
14. Drawing winners shall take all reasonable precautions to prevent fires, suppress fires and render all reasonable assistance in the suppression of refuge fires.
15. Drawing winners, harvest partners, and apprentices shall take all reasonable precautions to prevent nuisance wildlife by exercising due care when handling materials that are commonly known to attract wildlife.
16. Winning a drawing does not grant the ability to restrict other authorized entry in his or her area.
17. WEDNR reserves the right to revoke a drawing winner for noncompliance with applicable laws and regulations. WEDNR may also revoke a drawing winner for nonuse.
18. Drawing winners and harvest partners agree to hold White Earth Licensing Department, WEDNR, and USFWS harmless for any and all claims for damages or losses that may arise during the activity.
19. Drawing winners and harvest partners understand and accept the inherent risks involved in wild spaces.
20. Any personal property that remains 30 days after the termination of the permit’s expiration date shall become WEDNR or USFWS property. The failure to remove personal property may result in civil or criminal penalties.
21. Other conditions and regulations may apply. Permittees shall refer to the permit and its attachments or contact WEDNR for more information and questions.

C.C. 507.00 Refuge Manoomin (Wild Rice) Gathering Regulations

C.C. § 507.01 Manoomin Permits

1. Manoomin harvest in the Refuge is determined by joint effort between WEDNR’s Wild Rice Program and Refuge staff.
2. Interested White Earth tribal members may contact WEDNR’s Wild Rice Program Manager or the White Earth Wild Rice Committee for more information about ricing in the Refuge and seasons.

3. The WEDNR Wild Rice Program Manager shall publicly post information regarding ricing availability in the Refuge and conduct an informational meeting at least two (2) weeks in advance.
4. To be eligible persons must be 16 years of age or older, in good standing, possess a valid, unexpired White Earth Tribal Identification card, and a regular Harvest Permit issued by the White Earth Reservation Licensing Department are required to be in his/her possession when ricing.
5. Persons who are not White Earth Tribal members are not permitted by WEDNR to participate in ricing activities within the entirety of the Tamarac National Wildlife Refuge.
6. Harvest permits are nontransferable.
7. Apprentices may join to learn about ricing but they are the responsibility of the accompanying adult in the Refuge during the activity.
8. Permittees agree to assist WEDNR's mission by reporting approximate amount of Manoomin gathered and location(s) to a person authorized by the WEDNR Director upon request. Failure to provide this information may result in a loss of eligibility for future participation in activities.

C.C. § 507.02 Manoomin Regulations

1. The WEDNR works closely with White Earth Wild Rice Committee to make management decisions and determine the harvest season of wild rice in the Refuge.
2. WEDNR shall designate ricing access points and the number of boats allowed per lake for ricing as needed and distribute this information as attachments to permits and/or informational meetings.
3. All members of each ricing party are expected to follow regulations regarding gates in the Refuge, see intra Section 500.11.
4. Ricing hours are during daylight hours during the season.
5. It is prohibited to intentionally harm any plant or animal during ricing. Persons must take care and be respectful while ricing.
6. It is prohibited to take wild rice by any means except with:
 - a. a hand flail no longer than 30 inches and weight no more than one pound,
 - b. a canoe no more than 18 feet in length and less than 42 inches in width,
 - c. a push pole that has forks 12 inches or less; or
 - d. by foot.
7. The introduction of aquatic invasive species is strictly prohibited. Everyone participating in ricing activities is required to take all necessary precautions to avoid introducing or transporting aquatic invasive species. All ricing equipment such as boats, trailers, and push poles must be free of aquatic vegetation and all water needs to be drained before launching into Refuge lakes.

8. Littering, the abandonment of personal property, and leaving garbage is strictly prohibited.
9. Disturbance of the peace or disorderly conduct is strictly prohibited.
10. The permittee and all members of the ricing party accept the condition of the premise “as is” and agree to leave the premises in as good a condition as when they arrived except for reasonable wear and tear.
11. In the case of damages, the permittee is responsible to repay the Refuge or relevant party any and all damages as a direct or indirect result of his or her negligence or failure to act with care, and that of his or her apprentices.
12. All members of the ricing party shall take reasonable precautions to prevent fires, suppress fires, and render all reasonable assistance in the suppression of refuge fires.
13. All members of the ricing party shall take all reasonable precautions to prevent nuisance wildlife by exercising due care when handling materials that are commonly known to attract wildlife.
14. A regular Harvest Permit does not grant the ability to restrict other authorized entry in his or her permitted area.
15. WEDNR reserves the right to revoke any Harvest Permit for noncompliance with applicable laws and regulations. WEDNR may also revoke a permit for nonuse.
16. Permittees agree to hold White Earth Licensing Department, WEDNR, and USFWS harmless for any and all claims for damages or losses that may arise in the use of the Refuge harvest permit. Permittees understand and accept the inherent risks involved in wild spaces.
17. Any personal property that remains 30 days after the termination of the permit’s expiration date shall become WEDNR or USFWS property. The failure to remove personal property may result in civil or criminal penalties.
18. Refuge staff and WEDNR reserve the right to harvest wild rice for the purpose of re-seeding.
19. Other conditions and regulations may apply. Permittees shall refer to the permit and attachments issued by WEDNR or contact WEDNR for more information.

C.C. 508.00 Scientific Research on the Refuge

C.C. § 508.01 Scientific Research Permits

1. All persons or entities who desire to participate in a research activity on the Refuge may contact White Earth Reservation Review Board (WERRB) or WEDNR two (2) weeks in advance of the proposed research activity to determine whether or not a research permit or waiver will be needed.
2. Pursuant to the White Earth Nation’s Research Code, Resolution No. 001-17-008 permits are required when conducting research activities within the Reservation boundaries, and when research activities impact tribal ownership interests.

3. Research permits are nontransferable.
4. Certain routine activities performed by tribal employees in the usual course of their employment for the Band such as water sampling by WEDNR's Fisheries Division do not require a permit and may be granted a waiver by WERRB for business as usual.
 - a. WEDNR shall gather the person's name, current contact information, location of the activity, list of the impacted natural resource or targeted species, and timeframe on the Refuge for the research activity which WEDNR Director or other designated individual shall supply to the Refuge Manager at least 72 hours in advance when activities are considered business as usual. Only 24 hours' notice is required for rice and water sampling per the current Memorandum of Agreement between White Earth Band and United States Fish and Wildlife Service.
5. When a person or entity contacts either WERRB or WEDNR, the contacted division or board shall make a good faith effort to contact the other within 24 hours. WERRB and WEDNR shall coordinate to determine whether or not a permit is required for an activity. If a permit is required, the person shall need to fill out a completed application with WERRB pursuant to White Earth Nation Research Code.
6. Other conditions and regulations may apply. Permittees shall refer to the permit and attachments issued or contact WEDNR or WERRB for more information.

C.C. § 508.02 Scientific Research Regulations

1. White Earth Nation's Research Code enacted by Resolution No. 001-17-008 shall apply in the Refuge with respect to enrolled White Earth Tribal members and may apply to other persons conducting research activities in the Refuge pursuant to the Research Code and the aforementioned Section 508.01 herein.
2. Permittees must provide the names and, if applicable, contact information of each research associate participating in the research activity.
3. The permittee and research associates accept the condition of the premise "as is" and agree to leave the premises in as good a condition as when they arrived except for reasonable wear and tear.
4. In the case of damages, the permittee is responsible to repay the Refuge or relevant party any and all damages as a direct or indirect result of his or her negligence or failure to act with care, and that of his or her research associates.
5. Permittees and research associates shall take all reasonable precautions to prevent fires, suppress fires and render all reasonable assistance in the suppression of refuge fires.
6. Permittees and research associates shall take all reasonable precautions to prevent nuisance wildlife by exercising due care when handling materials that are commonly known to attract wildlife.
7. A Research permit does not grant the ability to restrict other authorized entry in his or her permitted area.

8. WEDNR and WERRB reserves the right to revoke any research permit for noncompliance with applicable laws and regulations.
9. WEDNR and WERRB may also revoke a research permit for nonuse.
10. Permittees, research associates, investigators, or other participants agree to hold the WEDNR, the WERRB, and the USFWS harmless for any and all claims for damages or losses that may arise in the use of the Refuge harvest permit. Permittees and all research participants understand and accept the inherent risks involved in wild spaces.
11. Any personal property that remains 30 days after the termination of the permit's expiration date shall become WEDNR or USFWS property. The failure to remove personal property may result in civil or criminal penalties.

C.C. 600.00 Forestry Provisions

C.C. 601.00 Forestry Permits

Subd.1) A Cutting Permit must be obtained from White Earth Tribal Forestry to cut standing dead, or dead and down stumpage.

Subd.2) A Cutting Permit must be obtained from White Earth Tribal Forestry for the cutting of standing green stumpage.

Subd.3) Any permit issued by White Earth Tribal Forestry is only valid on White Earth Tribal or Band lands.

C.C. 602.00 Forestry Rules and Regulations

Subd.1) It is prohibited for birch bark harvesters to cut down the entire paper birch tree to obtain the outer bark.

Subd.2) It is prohibited to harvest Christmas trees from Tribal plantations without the approval and a permit from White Earth Tribal Forestry.

Subd.3) It is prohibited to drive in Tribal plantations for any reason, except on established roads and trails.

Subd.4) It is prohibited to cut maple trees in known maple sugar camps.

Subd.5) It is prohibited for pinecone harvesters to cut down the entire pine tree to obtain the cones.

Subd.6) It is prohibited to cut or commercially harvest trees within a leased home site or home site area on the White Earth Reservation without a Cutting Permit from the White Earth Tribal Forestry or written permission from the White Earth Land Department.

Subd.7) Trespassing on Tribal land to harvest any other forest products without a permit from the White Earth Tribal Forestry or the White Earth Conservation Department is prohibited, except for ceremonial or religious purposes.

Subd.8) It is prohibited to place trees or parts of trees across or on the roadway, or to create a road hazard resulting from the act of gathering fuel wood.

Subd.9) It is prohibited to place a trailer or erect a building on a logging site on Tribal land, except by the approved purchaser who may erect or place a temporary structure during active harvesting of the timber sale.

C. C. 603.00 Fire and Burning Provisions

C.C. 603.01 Burning Permits

Subd.1) Open Burning Without a Permit: Open burning without a permit is allowed only when the ground is snow-covered or for recreational fires. All other forms of open burning require a permit.

Subd.2) Open Burning With a Permit: A permit for open burning may be issued for the following purposes:

- a) Elimination of fire or health hazards that cannot be abated by any other practical means;
- b) Disposal of vegetative matter for purposes of managing forests, prairies or wildlife habitats;
- c) Ground thawing for utility repair and construction;
- d) Disposal of trees, brush, grass and other vegetative matter in the development and maintenance of land and rights-of-way where chipping, composting, or other alternative methods are not practical;
- e) Disposal of diseased shade trees, infested nursery stock, or diseased bee hives;
- f) Disposal of burnable building material such as unpainted or untreated lumber, wood shakes, or other unpainted or untreated wood products generated by construction, where recycling, reuse, chipping or other alternative disposal methods are not practical.

Subd.3) Permits may be issued by designated employees of the White Earth Natural Resources Department, and appointed fire wardens.

Subd.4) A permit application submitted pursuant to these regulations may be denied if:

- a) A practical alternative method of disposal of the material is available, such as chipping or composting;
- b) The burning cannot be conducted according to the conditions established in these regulations; or
- c) A nuisance condition would result from the burning.

Subd.5) A permit is subject to revocation if:

- a) A practical method of disposal of the material is found;
- b) A fire hazard exists or develops during the course of the burning;
- c) The permittee violates this ordinance;
- d) Any of the conditions of the permit are violated; or
- e) A nuisance condition has resulted from the burning.

Subd.6) Program Established. The White Earth Natural Resources Department may establish a controlled burning program on Indian land to propagate wildlife requiring new vegetative growth and brush habitats, to manage the prairie, and to reduce the wildfire hazard.

Subd.7) Burning Permits. A person may not conduct a controlled burn without a permit.

C.C. 603.02 Burning Rules and Regulations

Subd.1) A permit for open burning may be issued under the following conditions:

The prevailing wind at the time of burning must be away from nearby residences and occupied buildings.

- a) The burning must be conducted as far away from a road as possible and controlled so that a traffic hazard is not created.
- b) The burning must be at least 50 feet away from any structure and 200 feet away from an adjacent owner's occupied structure.
- c) The burning must not be conducted within 500 feet of an airport or landing strip unless the affected airport or landing strip is notified prior to burning.
- d) The burning must not be conducted during the duration of a declared air pollution alert, warning, emergency, or significant harm episode as outlined in 40 CFR, Part 51, Subpart H or 40 CFR, Section 52.1220(c)(1).
- e) The person conducting the open burn shall give notice to the local authority and to a White Earth Natural Resources Department representative prior to any open burning within the White Earth Reservation. The notice must include the time and location of the fire.
- f) Propane gas torches or other clean gas burning devices causing minimal pollution must be used to start the burning.
- g) The person conducting the open burning must be present at the burn site from the commencement of burning until the fire is completely extinguished. If a permit is required, the permittee shall have a copy of the permit at the burning site at all times during the burning.
- h) Fires must not be allowed to smolder with no flame present, except when conducted for the purpose of managing forests, prairies, or wildlife habitats.
- i) Fires set or allowed to burn for the purpose of managing forests, prairies, or wildlife habitats must be managed according to a prescribed burn plan approved by the Bureau of Indian Affairs, Forestry.

Subd.2) Prohibited Materials: No person shall conduct, cause, or permit open burning of oils, rubber products, plastics, chemically treated materials or other materials which produce excessive or noxious smoke such as tires, railroad ties, chemically treated lumber, composite shingles, tar paper, insulation, composition board, sheetrock, wiring, paint, or paint filters.

- a) Hazardous Wastes: No person shall conduct, cause, or permit open burning of hazardous waste.
- b) Industrial Solid Waste: No person shall conduct, cause, or permit open burning of solid waste generated from an industrial or manufacturing process or from a service or commercial establishment.
- c) Demolition Debris: No person shall conduct, cause or permit open burning of burnable building material generated from demolition of commercial or institutional structures. A farm building is not a commercial structure.
- d) Salvage Operations: No person shall conduct, cause or permit salvage operations by open burning.
- e) Motor Vehicles: No person shall conduct, cause, or permit the processing of motor vehicles by open burning.
- f) Garbage: No person shall conduct, cause, or permit open burning of discarded material resulting from the handling, processing, storage, preparation, serving, or consumption of food.

Subd.3) Burning Ban. The White Earth Natural Resources Department may also, upon such determination, by written order, suspend the issuance of permits for open fires, revoke or suspend the operation of a permit previously issued and, to the extent the White Earth Natural Resources Department deems necessary, prohibit

the building of all or some kinds of open fires in all or any part of a wildfire area regardless of whether a permit is otherwise required; and the White Earth Natural Resources Department also may, by written order, prohibit smoking except at places of habitation or in automobiles or other enclosed vehicles properly equipped with a sufficient ash tray.

C.C. 603.03 Campfires

Subd.1) Extinguishment. Any authorized personnel of the White Earth Reservation who finds that any person has left a campfire burning shall take measures to extinguish the fire and take action against the person or persons responsible for leaving the campfire burning.

Subd.2) Not To Be Left Burning. Every person who starts a campfire shall exercise every reasonable precaution to prevent the campfire from spreading and shall, before lighting the campfire, clear the ground of all combustible material within a radius of five feet from the base of the campfire. The person lighting the campfire shall remain with the campfire at all times and shall completely extinguish the campfire before leaving the site.

C.C. 603.04 Assisting With Wildfire Suppression, Commandeering Property

Subd.1) Any able-bodied person so summoned who refuses or neglects or otherwise fails to assist in extinguishing such fire or who fails to make all reasonable efforts to that end, until released by the summoning Reservation employee, may be guilty of a misdemeanor.

Subd.2) An authorized personnel shall have power to commandeer, for the time being, equipment, tools, appliances, or other property in the possession of any person either summoned to assist in extinguishing the fire or in the vicinity thereof, and to use, and to require the persons summoned to use, the commandeered property in the fighting and extinguishing of the fire.

C.C. 603.05 Disposal of Slashings and Debris

Subd.1) Where and whenever in the judgment of the White Earth Natural Resources Department there is or may be danger of starting and spreading of wildfires from slashings and debris from the cutting of timber of any kind for any purpose, or from any accumulation of sawdust, shavings, chips, bark, edgings, slabs or other combustible refuse for the manufacture of lumber or other timber products, the White Earth Natural Resources Department shall order the person by or for whom the timber products have been or are being cut or manufactured to dispose of the same in such a way as to establish a safe fire line around the area requiring such protection, the fire line to be of a width and character satisfactory to the White Earth Natural Resources Department or otherwise to dispose of the same so as to eliminate the wildfire hazard.

Subd.2) When any person who has been directed by the White Earth Natural Resources Department to dispose of such slashings, debris, or refuse fails to comply with these directions, the person shall be deemed guilty of a misdemeanor.

Subd.3) When any such slashings, debris, or refuse are not disposed of or are left unattended for a period of time exceeding thirty (30) days contrary to the instructions of the White Earth Natural Resources Department or fire warden may go upon the premises with as many workers as may be necessary and burn or otherwise dispose of the same and the expense thereof shall be charged to the responsible party. An itemized statement verified by the White Earth Natural Resources Department of the amount of the costs and expenses incurred in burning or other disposal of these slashings, debris or refuse shall be filed within ninety (90) days from the time the disposal thereof is completed in the office of the Clerk of the White Earth Tribal Court. The amount of the

bill shall be a valid claim that may be collected in a civil action from the person who cut or manufactured the wood, timber, or timber products from which the slashings, debris or refuse were produced. Any monies so collected shall be paid to the White Earth Natural Resources Department and deposited according to departmental procedures.

Subd.4) Any person who cuts or fells trees or bushes of any kind in clearing land for any purpose is hereby prohibited from setting fire to any slashings, brush, roots, or excavated stumps or other combustible material on such land and letting the fire run; but the same must be disposed of pursuant to the rules or directions of the White Earth Natural Resources Department.

Subd.5) Any contractor who enters into a contract for the construction of a public road or other work, which involves the cutting or grubbing of woods, standing timber, or brush, shall properly dispose of such slashings and debris without damage to adjoining timber or woods. The foregoing provisions shall not prevent the leaving of such trees along roads as will be useful for ornamental purposes and which will not interfere with travel.

Subd.6) Every contract made by or on behalf of any municipality or political subdivision which involves the cutting of any timber on the right-of-way of a public highway shall provide terms for compliance with the foregoing provisions, but the failure to include this provision in the contract shall not relieve the contractor from the duty to dispose of these slashings.

Subd.7) In all cases herein provided for, where timber is not cut in, upon, or adjoining any forest land and no specific directions are given by the White Earth Natural Resources Department for the disposal of the slashings and debris resulting there from, all such slashings and debris within 200 feet of any adjoining timber land or any public highway, railroad, portage, or lake shore shall be properly disposed of by the person by or for whom the timber was cut.

Subd.8) No sawdust, shavings, chips, bark, edgings, slabs, or other combustible refuse that the White Earth Natural Resources Department or an agent of the White Earth Natural Resources Department determines to be a wildfire hazard shall be made or deposited upon any public highway or portage, railroad, or lake shore, or within 100 feet thereof.

C.C. 603.06 Starting Fires; Burners, Failure to Report a Fire

Subd.1) Except as provided in Subd.2 (a), it shall be unlawful to start or have any open fire without the written permission of the White Earth Natural Resources Department or an authorized fire warden.

Subd.2) No permit is required for the following fires:

- a) A fire started when the ground is snow-covered.
- b) A camp/ceremonial fire.
- c) A fire contained in a charcoal grill, camp stove, or other device designed for the purpose of cooking or heating.
- d) An open fire to burn dried vegetative materials and other materials allowed by White Earth ordinances and in a burner of a design which has been approved by the WETFP and with which there is no combustible material within five feet of the base of the burner and is in use only between the hours of 6:00 p.m. and 8:00 a.m. of the following day, when the ground is not snow-covered.
- e) For home heating purposes.

Subd.3) The occupant of any property upon which any unauthorized fire is burning, whether the fire was started by the occupant or otherwise, shall promptly report the fire to the nearest forestry office, fire department, or other proper authority. Failure to make this report shall be considered a violation of these regulations.

Subd.4) A permit to start a fire to burn vegetative materials and other materials allowed by these regulations or derivative regulations may be given by the White Earth Natural Resources Department or the White Earth Natural Resources Department agent or designee and shall be signed by said officer. The permit shall also specifically list the materials that may be burned. The permittee must have the permit on his or her person and shall produce the permit for inspection when requested to do so by the White Earth Natural Resources Department. The permittee shall remain with the fire at all times and before leaving the site shall completely extinguish the fire. A person shall not start or cause a fire to be started on any land that is not owned or under their legal control without the written permission of the owner, lessee, or an agent of the owner or lessee of the land. Violating or exceeding the permit shall constitute a violation of these regulations.

C.C. 603.07 Fire Wardens

Subd.1) The White Earth Natural Resources Department may appoint a responsible person(s) to be fire wardens in their respective areas.

C.C. 603.08 Wildfire Prevention; Prohibitions

Subd.1) Road Closure. When the White Earth Natural Resources Department shall determine that conditions conducive to wildfire hazards exist in the wildfire areas of the Reservation and that the presence of persons in the wildfire areas tends to cause wildfire hazards, render forest trails impassable by driving thereon during wet seasons and hampers the effective enforcement of White Earth Band timber trespass and game laws, the White Earth Natural Resources Department may, by written order, close any road or trail leading into any land used for any conservation purposes, to all modes of travel except that considered essential such as residents traveling to and from their homes or in other cases to be determined by the authorized forest officers assigned to guard the area.

C.C. 700.00 Raptor Provisions

C.C. 701.00 Eagles

Subd.1) It is prohibited for any person to take or transport any bald eagle or any golden eagle, or the parts, nests, or eggs of such birds at any time or in any manner, except on the provision of the Indian Freedom of Religion Act, or permitted under the terms of a valid permit issued pursuant to the provisions in **C.C. 701.01, Eagle Permit and Eagle Feather Bank.**

Subd.2) It is prohibited for any person to barter, trade, sell, purchase, offer for sale, export or import any bald eagle or any golden eagle, or the parts, nests, or eggs of such birds at any time or in any manner.

Subd.3) It is prohibited for any person to pursue, shoot, shoot at, poison, wound, kill, capture, trap, collect, molest, or disturb any bald eagle or any golden eagle or its nests or eggs at any time or in any manner.

Subd.4) It is prohibited to place a road or building within one-half (1/2) of a mile from an established eagle's nest.

C.C. 701.01 Eagle Permit and Eagle Feather Bank

Subd.1) If any eagles are found dead within the boundaries of the Reservation caused by natural causes or accidental death, that eagle must be turned over to the White Earth Conservation Department for documentation of death. A report and autopsy must be conducted by the U.S. Fish and Wildlife Service. The eagle will be sent back to the Reservation and be given back to the party that found the eagle or be put into an eagle feather bank for religious or ceremonial purposes.

Subd.2) The White Earth Reservation Tribal Council may, upon receipt of an application and in accordance with the issuance criteria of this Section, issue a permit authorizing possession or transportation of bald eagles or golden eagles or its parts. Requirements of the permit are as follows:

- a) Fill out Application
- b) State the number of eagle feathers and the purpose for which they will be used; religious or ceremonial.
- c) Applicant must attach a certification from the Bureau of Indian Affairs that the applicant is an enrolled member of a federally recognized tribe.
- d) State the local area where the majority of his/her religious practices take place.
- e) The applicant must be sponsored, in writing or in person, by a known spiritual leader or medicine man that the applicant participates in such ceremonies.

Subd.3) Applications for permits may be picked up at the White Earth Conservation Department.

Subd.4) The permits are not transferable, except such birds or its parts may be handed down from generation to generation or from one Indian to another in accordance with tribal or religious customs.

C.C. 702.00 Commercial Uses of Feathers

Subd.1) Any person may possess, purchase, sell, barter, or transport for the making of fishing flies, bed pillows, and mattresses, and for similar commercial uses the feathers of migratory game bird (ducks, geese, brant and swans) killed by hunting under this part, or seized and condemned by the White Earth Reservation Natural Resources Department or the White Earth Reservation Conservation Department, except that:

- a) No person may purchase, sell, barter, or offer to purchase, sell, or barter for millinery or ornamental use the feathers of migratory game birds taken under authority of this part; and
- b) No person may purchase, sell, barter, or offer to purchase, sell, or barter mounted specimens of migratory game birds taken under authority of this part.

C.C. 800.00 Recreational Vehicle Provisions

C.C. 801.00 Boats and Watercraft Registration Provisions

C.C. 801.01 Boats and Watercraft Registration

Subd.1) It is prohibited to operate an unlicensed boat or watercraft on any body of water within the exterior boundaries of the White Earth Reservation, except a canoe that's used specifically for ricing or waterfowl hunting. Non-motorized watercrafts 9 feet in length or less are exempt from the registration requirements.

Subd.2) Failure to display a valid registration is prohibited within the exterior boundaries of the White Earth Reservation.

Subd.3) Failure to notify the White Earth Licensing Department of transfer of boats and watercraft ownership is prohibited.

Display of numbers/letters

- Registration numbers must be painted or permanently attached to each side of the forward half of the vessel.
- The numbers and letters must be of a contrasting color to the background color of the vessel.
- A valid White Earth registration decal must be affixed to the rear of the vessel and within four inches of the license number area.
- Lettering/numbering must be in plain, vertical block characters of not less than 3 inches in height.
- Spaces and or hyphens between letter and number groupings must be equal to the width of a letter other than “I” or a number other than “1”.
- No other number, letter, or design may appear within 24 inches of the license number or decal.

Starboard (right) side



3” { 

White Earth
Registration
Decal

Front of vessel →



WE	1234	MB
White Earth (Place of registration)	Registration# from Decal	Type of craft
License number area		

← Front of vessel Port (left) side



Watercraft types

- MB-motorized boat or watercraft
- PW-personal watercraft (i.e.; jet skis)
- AV-amphibious vehicle (i.e.; Argo)
- NM-non motorized boat or watercraft

- The registration number issued to your craft appears on the registration decal.
- If your canoe, kayak, rowing shell, paddle boat, sailboard, or sailboat doesn't have a motor, place the registration decal on each side of the forward half of the craft. No 3 inch numbers are necessary. (See illustration below)

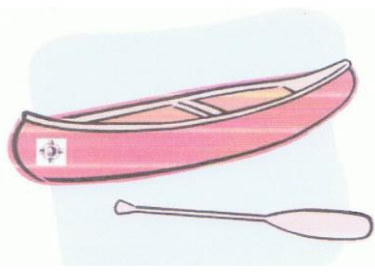

- You may also place the registration decal on the stern if it is impossible, because of the boat's design, to place them on the bow.

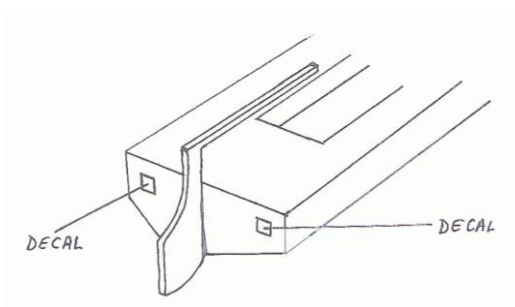

C.C. 801.02 Boats and Watercraft Rules and Regulations

Subd.1) It is prohibited to operate boats and watercrafts in a careless manner, or in disregard for the rights and safety of others.

Subd.2) It is prohibited to operate boats and watercrafts in such a manner that its wake or wash endangers, harasses, or unnecessarily interferes with other people or the property of others.

Subd.3) It is prohibited to operate boats and watercrafts within an area legally marked or set aside as a swimming area, or within 150 feet of a 'Diver Warning' flag.

Subd.4) An operator must stop his/her boat and/ or watercraft when signaled to do so by a Tribal Conservation Officer or other Law Enforcement Officer.

Subd.5) Any person between 12 to 15 years of age may operate a motor of any horsepower, but only if he/she is accompanied by a person at least 18 years of age, or alone if he/she has in his/her possession and on his/her person a Boating Safety Certificate issued either by the State or a duly authorized Band official.

Subd.6) No person under the age of 10 years shall operate a boat or watercraft.

Subd.7) Any person at least 10 and less than 12 years of age may operate a motorized boat or watercraft only if he/she is accompanied in the boat or watercraft by a person at least 18 years of age.

Subd.8) It is prohibited to operate a boat and watercraft while towing a water skier or similar person without an observer or rear view mirror.

Subd.9) It is prohibited to operate a boat and watercraft while under the influence of a controlled substance or alcohol.

Subd.10) Failure to stop a boat or watercraft when involved in an accident, or failure to make a report of an accident to the proper authorities is prohibited.

Subd.11) It is prohibited to operate a boat or watercraft without having at least 1 lifesaving device per person on board the boat or watercraft. For the purposes of this Code, people being towed by a watercraft on water skies or other device are considered to be on board the watercraft.

Subd.12) All personal flotation devices must be approved by the U.S. Coast Guard, free of defects, and readily accessible in the event of an emergency or worn. Flotation devices must be the appropriate size for the intended wearer. Personal floatation devices are to be worn by people under **10** years of age, unless they are on a boat that is anchored for the purpose of swimming or diving.

Subd.13) It is prohibited to operate a boat or watercraft without properly displayed navigational lights from sunset to sunrise, and other periods of reduced visibility (fog, rain, haze, etc.). See Subd.54), **C.C. 101.00**

Definitions.

Subd.14) All non-motorized boats or watercraft, whether underway or at anchor, must carry at least a white lantern or flashlight.

Subd.15) It is prohibited to remove, destroy or damage buoys.

Subd.16) Any type of watercraft with altered or removed serial/Hull identification numbers may not be registered within the exterior boundaries of the White Earth Reservation.

C.C. 801.03 Personal Watercraft (PWC) Rules and Regulations

In addition to the watercraft regulations listed above, Personal Watercraft (PWC) must also observe the following regulations;

Subd.1) Operators and passengers are required to wear a U.S. Coast Guard (USCG) approved Type I, II, III, or V personal flotation device.

Subd.2) All personal watercraft must carry a USCG approved fire extinguisher.

Subd.3) Personal watercraft must travel at slow-no wake speed (5 mph or less) within 150 feet of: shore (except when a PWC is launching or landing a water skier by the most direct route to open water), docks, swimmers, swimming rafts, any moored or anchored watercraft, or non-motorized watercraft.

Subd.4) Any PWC towing a person on water skis or other device, must have another person on board to act as an observer. Rear view mirrors may be substituted for an observer but must be factory installed or specified by the manufacturer.

Subd.5) Cutoff lanyards must be properly used and attached to the person, life vest or clothing of the operator.

Subd.6) PWC may only be operated between 9:30 A.M. and one hour before sunset.

Subd.7) It's prohibited to chase or harass wildlife

Subd.8) PWC may not be operated while the operator is facing backwards.

Subd.9) It's prohibited to operate a PWC if the spring-loaded throttle mechanism has been removed or tampered with so it interferes with the return-to-idle system.

Subd.10) It's prohibited to weave through congested watercraft traffic or to jump the wake of another watercraft within 150 feet of the other boat.

Subd.11) It's prohibited to travel through emergent or floating vegetation at greater than a slow-no wake speed.

Subd.12) It's unlawful for the PWC owner to allow operation in violation of the age restrictions listed below.

- Less than 13 years old
 - 13 years old
 - 14-17 years old
- May not operate, even with an adult on board.
Must either have:
- Someone at least 21 years of age on board.
 - A watercraft operator's permit and be in continuous visual observation by someone at least 21.
- Must either have:
- A watercraft operator's permit.
 - Someone at least 21 on board.

C.C. 802.00 Off-Highway Vehicles (OHV) Provisions

The OHV Permits and Rules and Regulations apply to ALL Off-Highway Vehicles: this includes All Terrain Vehicles (ATV's), Off-Highway Motorcycles (OHM's), and Off-Road Vehicles (ORV's).

C.C. 802.01 OHV Permits

Subd.1) It is prohibited to operate an unregistered OHV on public lands and/or waters within the exterior boundaries of the White Earth Reservation.

Subd.2) Failure to properly display a valid registration on an OHV is prohibited.

C.C. 802.02 OHV Rules and Regulations

Subd.1) An operator may not enter or leave lands by cutting wire or tearing down a fence.

Subd.2) It is prohibited to post, damage, or remove any signs on any lands or waters unless you are the landowner, occupant, or lessee of the property.

Subd.3) It is prohibited to fail to yield.

Subd.4) It is prohibited to cross a road without lights after dark.

Subd.5) It is prohibited to operate in an unsafe or harassing manner.

Subd.6) It is prohibited to operate at a greater rate of speed than circumstances allow.

Subd.7) It is prohibited to operate in a careless, reckless or negligent manner or to cause injury or damage to persons, animals, property, roads, land or other natural resources.

Subd.8) An operator must stop when signaled to do so by a Tribal Conservation Officer or other Law Enforcement Officers using, lights, siren, hand signals or a combination of these acts.

Subd.9) Motor vehicle operation is prohibited on or over the beds of lakes, rivers, streams or other wetland areas except on a bridge, culvert, designated low water crossing or when the water body is ice covered.

Subd.10) Any person under the age of 18 must wear a helmet approved for such operation.

Subd.11) Grant-in-Aid snowmobile trails and non-motorized trails are closed to all OHV's unless the operator is an enrolled Tribal member specifically exercising a Treaty right, (Hunting, fishing, trapping and gathering) or any activity relating to a Treaty right. (Erecting a deer stand, transporting a fish house to a lake.

Subd.12) Operating an OHV while under the influence of alcohol, controlled substance, or other hazardous substance is unlawful.

C.C. 802.03 All-Terrain Vehicles (ATV's) Rules and Regulations

Subd.1) Class 1 ATV operation:

Under age 10

- a) May operate only on private property with landowner's permission.
- b) Must have parent or guardian permission to operate.
- c) May not carry passengers.

10-11 year olds

- a) May operate only on private property with landowner's permission.
- b) May operate ATV up to 90cc on public lands and frozen waters if accompanied by parent or legal guardian.
- c) Must have parent or guardian permission to operate
- d) May not carry passengers.

12-15 year olds

- a) Must have an ATV safety certificate valid only after successfully completing BOTH the ATV Safety Training CD and Safety Training class.
- b) Must be able to properly reach and control the handlebars and foot pegs while sitting upright on the seat.
- c) May operate an ATV on public lands and frozen waters and make direct crossing of roadways with a valid safety certificate if accompanied on another ATV by a person 18 or over who has a valid driver's license.
- d) Must have parent or guardian permission to operate.
- e) May not carry passengers.

16-17 year olds

- a) Must successfully complete the ATV Safety Training CD before operating on public lands, frozen waters, public road rights-of-way or state or grant-in-aid trails where permitted.
- b) Must have a valid driver's license to make a direct crossing of a roadway or operate on road rights-of-way.
- c) May carry one passenger if the ATV is manufactured for such use.

Subd.2) Class 2 ATV operation:

Under 15 years old

- a) May not operate.

15-17 year olds

- a) May operate a Class 2 ATV.
- b) Must have a valid driver's license to make a direct crossing of a roadway or operate on road rights-of-way unless a designated trail includes the right of way.
- c) Must wear a seat belt if provided by the manufacturer.

15 year olds

- a) Must have an ATV safety certificate valid only after successfully completing BOTH the ATV Safety Training CD and Safety Training class.
- b) Must be able to properly reach and control the handlebars and foot pegs while sitting upright on the seat.
- c) May operate a Class 2 ATV on public lands and frozen waters and make direct crossing of roadways with a valid safety certificate if accompanied on another ATV by a person 18 or over who has a valid driver's license.
- d) Must have parent or guardian permission to operate.

16-17 year olds

- a) Must successfully complete the ATV Safety Training CD before operating on public lands, frozen waters, public road rights-of-way, or state or grant-in-aid trails.

18+ years

- a) Operators can carry one passenger or up to the number of passengers the machine is designed to carry, whichever is greater.
- b) Must have a valid driver's license to operate on the shoulder of a roadway, make a direct crossing of a roadway.

Subd.3) It's prohibited to operate an ATV exceeding 10 MPH on the frozen surface of public waters within 100 feet of another person that is not on an ATV (including people fishing) or within 100 feet a fish house or shelter.

Subd.4) It's prohibited to operate a Class 1 ATV within a road right-of-way of a trunk, county, state aid, or county highway unless it's registered for private use and being used for agricultural purposes. Vehicle operation is limited to the extreme right side of the roadway and operator must have a valid driver's license.

Subd.5) A person with a valid driver's license may operate an ATV on the far right hand side of a township road.

Subd.6) ATV's equipped with headlights and tail lights must have them on at all times.

Proper Display of numbers/letters

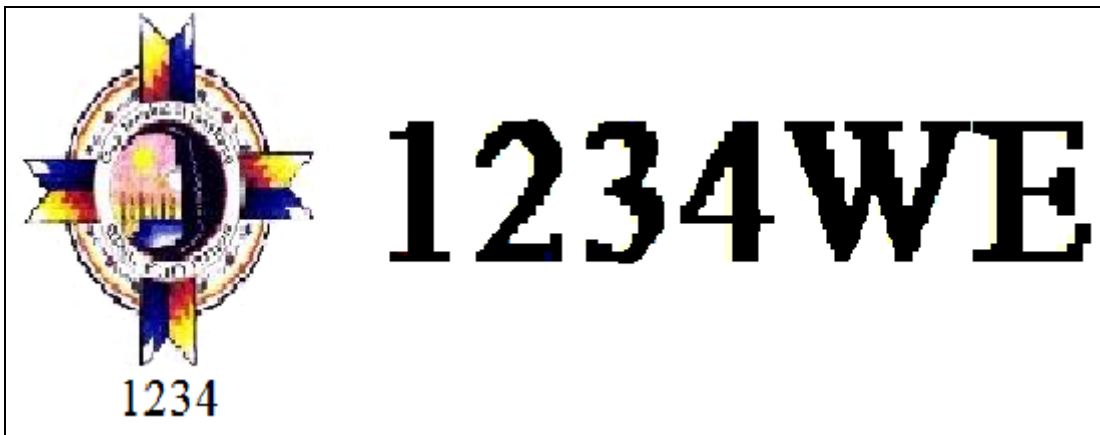

- 1 Registration decal with the White Earth logo must be placed on the outside, where it can be plainly seen from either of the sides or the front of the vehicle.
- The other Registration decal, along with the corresponding numbers/letters, must be displayed on a plate at least 4 inches high by 7 ½ inches long.
- Plate must be clearly visible on the back of the vehicle and at least 12 inches from the ground.
- The registration plate must be maintained in a clear and legible condition.

- Numbers/letters following the registration decal must be at least 1 ½ inches high and with a 3/16 inch stroke, in English placed left to right and in a color that contrasts with the background of the plate.
- The letters “WE” must be displayed on the right side of the plate.
- The registration numbers from the White Earth decal must precede the “WE” lettering, as shown in the diagram above.

C.C. 802.04 Mini-Trucks

Subd.1) A person under 16 years of age may not operate a mini-truck.

Subd.2) It’s prohibited for an owner to allow a min-truck to be operated by a person under 16 years of age.

Subd.3) It is prohibited for an operator under the age of 18 years to carry passengers.

Subd.4) All mini-truck passengers and operators must wear seat belts.

Subd.5) It is prohibited for the operator to allow passengers in the bed or rearmost portion of the vehicle.

Subd.6) A valid driver’s license is required to operate on or cross roads, unless that portion is designated as a trail within the road right-of-way.

Subd.7) It’s prohibited to operate mini-trucks on designated trails unless equipped with flotation tires or tracks to minimize impact and compaction of the soil.

Subd.8) Mini-trucks used on any highway as implements of husbandry (leeching, gathering firewood, treaty activity, etc...) will have either standard tires intended for highway use or flotation tires.

Subd.9) Mini-trucks operating within a public road right-of-way will not exceed 30 miles per hour and properly display a slow moving vehicle sign on the rear of the vehicle.

C.C. 802.05 Off-Highway Motorcycles (OHM’s) Rules and Regulations

Subd.1) Off-Highway Motorcycle operation:

Under age 12

- a) May not make a direct crossing of a public road right-of-way.
- b) May not operate OHM on a public road or a public road right-of-way.
- c) May not operate OHM on public lands or frozen public waters unless accompanied on another OHM by a person 18 years of age or older with a valid driver’s license.
- d) Must possess a valid OHM safety certificate to operate on public lands or frozen public waters.
- e) Must wear eye protection.

Under 16

- a) Must possess a valid OHM safety certificate to operate on public lands or frozen public waters.
- b) May make a direct crossing of a public road (except an interstate highway) if accompanied on another OHM by a person 18 years of age or older with a valid driver’s license.
- c) Must wear eye protection.

16-17 year olds

- a) Must have driver’s license to operate on a public roadway, unless an OHM trail specifically includes the road right-of-way, and the motorcycle must be licensed for highway use.

b) Must wear eye protection.

Subd.2) Off-Highway Motorcycles (OHM) may not be operated in ditches unless it is a trail designated for OHM use. OHM's registered for highway use may operate on roadways.

Subd.3) A valid driver's license with motorcycle endorsement is required to operate anywhere on road rights-of-way including crossing roads unless those portions are designated for OHM use.

Subd.4) It's prohibited to operate an OHM exceeding 10 MPH on the frozen surface of public waters within 100 feet of a person fishing or a fish house or a shelter.

Subd.5) It's prohibited to operate an OHM on public roads without a headlight, tail light, and brakes. Lights will be used one half hour after sunset to one half hour before sunrise and during conditions of reduced visibility.

Proper Display of numbers/letters

- OHM's registered for off-road use only must display the White Earth registration decal on the side of the OHM so it is visible while the rider is on the OHM. It may be attached to the fork tube.
- OHM's licensed for both roadway use and off-road use must display the motorcycle license plate and the White Earth registration decal according to the off-road requirements.

C.C. 802.06 Off-Road Vehicles (ORV's) Rules and Regulations

Snowmobiles, ATV's, OHM's, motorcycles, watercraft or aircraft aren't considered ORV's.

Mini-trucks, farm, logging, military, emergency, law enforcement, utility, trail grooming, and construction vehicles aren't considered ORV's when used for their intended purpose.

Subd.1) A person under 16 years of age may not operate an ORV.

Subd.2) It's prohibited for an owner to allow an ORV to be operated by a person under 16 years of age.

Subd.3) All ORV passengers and operators must wear seat belts.

Subd.4) A valid driver's license is required to cross roads, unless that portion is designated as a trail within the road right-of-way.

Subd.5) ORV's are required to have lights on when crossing public roads one half hour after sunset to one half hour before sunrise and during periods of limited visibility.

Subd.6) ORV's may be operated on State Forest roads and trails only, unless posted closed.

Subd.7) ORV's may not be operated within the right-of-way of an interstate highway, or within a public road right-of-way, except on a designated trail.

Proper Display of numbers/letters

- ORV's registered for trail or designated area use must display the current White Earth registration decal on a plate at least 4 inches high and 7 ½ inches long.
- The plate must be clearly visible on the rear of the vehicle and at least 12 inches from the ground.

- The plate must be maintained in a clear and legible condition.



1234

- ORV's registered for **both** roadway use and off-road use on trails or designated areas must display the current White Earth registration decals anywhere within 6 inches of the motor vehicle license plate.
- Registration decals and motor vehicle license plates must be displayed on both front and back of the vehicle.

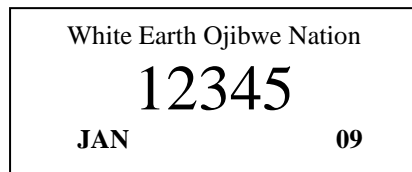

Tribal or State motor vehicle license plate



1234

White Earth Registration Decal

C.C. 802.07 Snowmobiles Rules and Regulations

Subd.1) It is prohibited to operate an unregistered snowmobile on public lands and/or waters within the exterior boundaries of the White Earth Reservation.

Subd.2) Failure to properly display a valid registration on a snowmobile is prohibited.

Subd.3) Maximum speed allowed is 50 MPH unless posted otherwise.

Subd.4) It is prohibited to operate a snowmobile on the roadway, shoulder or inside slope of a Tribal, State or County road, unless that portion is part of a designated snowmobile trail.

Subd.5) Snowmobile operation must be in the same direction as roadway traffic when riding one half hour after sunset to one half hour before sunrise.

Subd.6) Anyone under 18 years of age must have a Snowmobile Safety Certificate issued by a State or duly authorized Tribe in order to operate a snowmobile on public lands and/or waters. A valid driver's license can be used in lieu of a Safety Certificate.

Subd.7) Cross public roadways at a 90 degree angle.

Subd.8) Operators or riders under 18 years of age must wear an approved helmet, except when in a parade or operating on land belonging to a parent, grandparent, sibling, uncle, or aunt.

Subd.9) It is unlawful to operate a snowmobile without working headlights and/or taillights during the hours of darkness or when crossing a road or when operating in the ditch or outside slope.

Subd.10) It is prohibited to operate a snowmobile without at least 16 square inches of reflective material on each side forward of the handlebars.

Subd.11) The owner or person in lawful control of a snowmobile is jointly responsible for laws broken by a minor on that snowmobile.

Subd.12) It is unlawful to operate a snowmobile in a careless, reckless or heedless manner that endangers the operator, or property of another, or causes injury or damage

Subd.13) Non-motorized trails are closed to all snowmobiles, unless the operator is an enrolled Tribal member specifically exercising a Treaty right, (Hunting, fishing, trapping and gathering) or any activity relating to a Treaty right. (Erecting a deer stand, transporting a fish house to a lake.

Subd.14) An operator may not enter or leave lands by cutting wire or tearing down a fence.

Subd.15) It is prohibited to post, damage, or remove any signs on any lands or waters unless you are the landowner, occupant, or lessee of the property. (Make sure to address the lessee part in Tribal trail leases.)

Subd.16) It is prohibited to fail to yield.

Subd.17) An operator must stop when signaled to do so by a Tribal Conservation Officer or other Law Enforcement Officers using, lights, siren, hand signals or a combination of these acts.

Subd.18) It is prohibited to chase, run over, or kill a wild animal.

Subd.19) Operating a snowmobile while under the influence of alcohol, controlled substance, or other hazardous substance is unlawful.

Proper Display of numbers/letters

- The White Earth issued registration decal must immediately follow the corresponding registration numbers/letters.
- Registration numbers/letters must be at least 1 7/8 inches high with a 3/16 inch stroke width and be in a contrasting color of the snowmobile.
- Registration numbers/letters will be in the English language and placed to read left to right, either on the cowling pan or on each side of the snowmobile on the upper half, forward of the handlebars in a visible location.

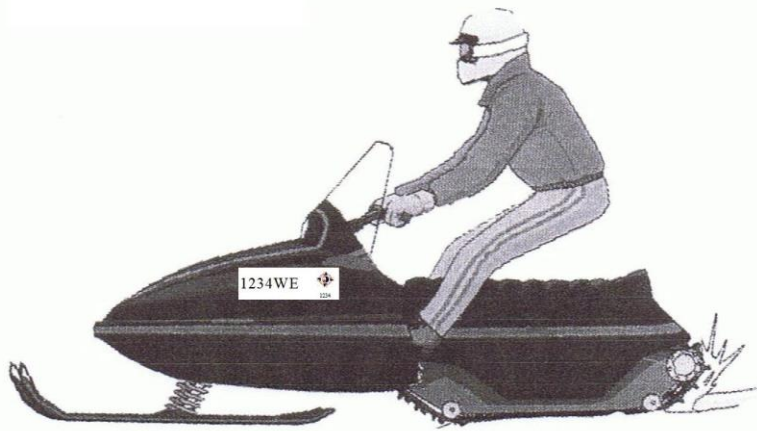

C.C. 900.00 Parks and Recreation Provisions

C.C. 901.00 Park Violations

Subd.1) Motor Vehicles are permitted only on established routes.

Subd.2) Disorderly conduct, amplifiers, power equipment or loud noises are prohibited in the park.

Subd.3) Motor vehicles must not be operated in a careless or reckless manner in the park.

Subd.4) A person must obtain permission from the Director of Natural Resources to peddle, solicit, or advertise within the park.

Subd.5) There must not be any destruction or damage to any plants or injury or molestation to any wildlife in the park.

Subd.6) It is prohibited to cut timber in a park or management area or refuge.

Subd.7) All pets in the park must be on a leash.

Subd.8) Possession of firearms will be in accordance with Federal, State and/or Tribal Regulations, i.e. permits to carry or concealed carry permits.

Subd.9) Firearms used for hunting while staying at the park must be noted on the camping permit.

C.C. 902.00 Fires

Subd.1) All campfires must be extinguished upon departure.

Subd.2) All debris/garbage must be disposed of properly.

Subd.3) All campfires must be personally supervised.

Subd.4) It is prohibited to burn without having a valid burning permit on your person excluding campfires.

Subd.5) All wild fires must be reported.

Subd.6) It is prohibited to start a fire and leave it unquenched.

Subd.7) It is prohibited to drive over forest land without a muffler.

C.C. 1000.00 Commercial Provisions

C.C. 1001.00 Commercial Fishing Provisions

C.C. 1001.01 Commercial Non-Game/Rough Fish Harvesting Permit

Subd.1) It is prohibited to take fish, or parts of fish, which includes the stripping thereof and its products to raise or propagate fish, for commercial use without first obtaining a Commercial Permit from the White Earth Natural Resources Department.

Subd.2) Carp shall not be returned to any body of water.

Subd.3) It is prohibited to stock, or plant any body of water with game, non-game/rough, or crayfish, without first obtaining a Stocking Permit from the White Earth Natural Resources Department.

Subd.4) All aspects of commercial use harvesting operations shall be open at all times to inspection and observation by the White Earth Conservation Department and/or White Earth Natural Resources Department. This includes, but is not limited to, netting site, transport equipment, holding facilities, storage facilities, or the place of business.

Subd.5) Permittee shall keep records on forms provided by the White Earth Natural Resources Department when so required by the White Earth Tribal Council including: harvest poundage or numbers by species, by lake, and the reports shall be submitted to the White Earth Natural Resources Department biannually, January 1 and May 31. All reports must be submitted in a timely and accurate manner.

Subd.6) Permittee shall utilize only nets and traps that capture fish alive. In no case shall gill nets, explosives, poison, or electricity be utilized. All equipment shall be inspected and approved by the White Earth Conservation Department and/or White Earth Natural Resources Department.

Subd.7) Permittee must list what lakes will be harvested and receive approval from the White Earth Natural Resources Department prior to setting any net or trap in any lake. All permittees must actively and regularly harvest fish at least 3 months of the year.

Subd.8) All live game fish harvested shall be immediately returned to the water body harvested. Any game fish that is dead shall be given to the White Earth Conservation Department or other designated authority or drop off point. All rough fish, as defined by the White Earth Conservation Code, may be taken and sold by the permittee.

Subd.9) Permittee must obtain a Commercial Fishing License by payment of an annual fee of \$35.00, and agreement to the terms of the permit. Permits are renewable March 1 of each year.

Subd.10) Permittee must tend nets at such a frequency that there is less than 10% loss of fish by number.

Subd.11) Violation of any of the provisions of the White Earth Conservation Code, or his/her permit, shall subject the permittee to immediate, temporary revocation of the permit, until such time that a full hearing may be heard of the case. If the person is found guilty of any of the provisions of the White Earth Conservation Code, or his/her permit, the permittee is subject to permanent loss of the permit.

Subd.12) The White Earth Tribal Council reserves the right to, at its discretion, requires a \$1000.00 bond payable to the White Earth Tribal Council to be utilized as payment of fines, penalties, or for cleanup of violations if permittee is convicted of a violation of the terms of the permit.

Subd.13) A Transport Permit must be obtained from the White Earth Natural Resources Department before transport of any fish.

Subd.14) Wanton waste of fish or other aquatic life is prohibited.

C.C. 1001.02 Private Game Fish Culture Permit

Subd.1) Permittee shall utilize proper hatching and rearing facilities suitable for the culture of the fish species chosen. The White Earth Natural Resources Department shall inspect all facilities prior to operation by the permittee.

Subd.2) Permittee shall utilize only nets and traps that capture fish alive. In no case shall gill nets, explosives, poison, or electricity be used. The White Earth Natural Resources Department shall inspect all equipment prior to use.

Subd.3) All game fish to be reared will be provided by the White Earth Natural Resources Department through either purchase, trade, or obtained through another legal supplier.

Subd.4) All rearing operations will take place only in approved sites with written authorization from the White Earth Natural Resources Department.

Subd.5) Rearing ponds and lakes will be permitted for use only if there are no populations of game fish and they are isolated from migratory populations.

Subd.6) It is illegal for any permittee to trap any game fish under these regulations from a wild brood stock for the purpose of stripping under these regulations.

Subd.7) Permittee must obtain a Private Game Fish Culture Permit by payment of a fee of \$35.00, and agreement to the terms of the permit. The permit is renewable March 1 each year, for up to 5 years.

Subd.8) Permittee must submit, in a timely manner, complete and accurate records of all aspects of the game fish culture operation provided by the White Earth Natural Resources Department.

Subd.9) Convictions or violations of any of the provisions of this permit, or the White Earth Conservation Code, may result in immediate, temporary revocation of the permit.

Subd.10) There shall be no exotic fish stored, reared, transported, or released in Reservation lakes, or waters.

Subd.11) A Transport Permit must be obtained from the White Earth Natural Resources Department.

C.C. 1001.03 Commercial Bait Fish Aquaculture Permit

Subd.1) Permittee shall utilize only nets and traps that capture fish alive. In no case shall gill nets, explosives, poison, or electricity be used. The White Earth Natural Resources Department shall inspect all equipment prior to use.

Subd.2) Permittee shall utilize proper hatchery and rearing facilities suitable for the culture of the fish species chosen. All facilities are subject to prior and frequent inspections by the White Earth Natural Resources Department.

Subd.3) All trapping and rearing operations will take place only in previously approved sites with written authorization from the White Earth Natural Resources Department.

Subd.4) All trapping and rearing sites shall be open to inspection by the White Earth Natural Resources Department.

Subd.5) Permittee must obtain permission before entering private land.

Subd.6) All live game fish at the trapping site shall be returned to the native body of water immediately.

Subd.7) All game fish mortalities shall be turned over to the White Earth Natural Resources Department.

Subd.8) The White Earth Natural Resources Department must approve all brood fish trapping sites.

Subd.9) Permittee must submit, in a timely manner, complete and accurate records of all aspects of the Bait Fish Aquaculture operation. The White Earth Natural Resources Department will provide forms.

Subd.10) Permittee must obtain a Commercial Bait Fish Aquaculture Permit by payment of a fee of \$35.00, and agreement to the terms of the permit. Permits are renewable March 1 of each year.

Subd.11) It is prohibited to rear, carp, tilapia, smelt, white amur, and goldfish.

Subd.12) A Transport Permit must be obtained from the White Earth Natural Resources Department before transport of any fish.

C.C. 1001.04 Fishing Tournaments

Subd.1) Permittee making the request must be an enrolled member of the White Earth Band of Ojibwe and at least 18 years of age.

Subd.2) All Boat Safety (**C.C. 800.00 Recreational Vehicle Provisions**) and Angling Regulations (**C.C. 200.00 Fishing Provisions**) as provided by the White Earth Reservation Conservation Code and/or the State of Minnesota must be followed.

Subd.3) Sponsor must provide permit upon request by White Earth Tribal Conservation Officer.

Subd.4) Reporting Information Requirements must be submitted to the White Earth Reservation Natural Resources Department within 60 days after the event.

- a) Total weight of fish entered by species
- b) Total number of fish entered by species
- c) Total number fish released by species
- d) Total number of fish harvested by species
- e) Total number of entrants
- f) Total number of boats
- g) Name of Sponsor
- h) Name of Tournament Waters/D.O.W. ID Number
- i) List of Weigh-In Stations
- j) Tournament Dates and Times

C.C. 1002.00 Leeching Provisions

C.C. 1002.01 Leeching Permits

Subd.1) All persons that are 12 years of age or older involved in the tending of leech traps must have in his/her possession and on his/her person a valid Natural Resources Harvest Permit, Leeching Permit, and valid unexpired Tribal Identification Card.

Subd.2) The authority to take leeches under this permit is non-transferable.

Subd.3) Permittee may start leeching on March 31 and continue until October 31 of each year and providing that the traps are not left on top of the ice. Tamarac National Wildlife Refuge has its own set of rules for leeching.

Subd.4) Possession of less than 12 dozen leeches, whether live or dead, doesn't require a Leeching Permit. This is considered personal use and only requires a Natural Resource Harvest Permit.

Subd.5) Trapping leeches for personal use must still follow the rules under **C.C. 1002.02 Leeching Rules and Regulations.**

C.C. 1002.02 Leeching Rules and Regulations

Subd.1) All leech trap floats must be permanently marked with the owner's name, or tag number or Tribal Identification number.

Subd.2) All traps' identification must be clearly visible above the surface of the water.

Subd.3) Traps of one permittee shall not be within 50 feet of another permittee's traps.

Subd.4) It is prohibited to tend or disturb the traps of another without his/her written permission.

Subd.5) Wanton waste of leeches or other aquatic life is prohibited. Leech traps shall be checked at least once every 72 hours.

Subd.6) It is prohibited to litter. All litter, i.e. trash, excess bait, fish remains, etc., must be removed from the leeching area daily, and properly disposed of. At no time shall traps be left on the water or on the shore until the next year.

Subd.7) The Leeching Permit is a legal Transport Permit.

Subd.8) A person should have a personal floatation device described under Subd.11 **C.C. 801.01 Boats and Watercraft Rules and Regulations.**

Subd.9) The use of firearms, explosives, poisons, and electric shock equipment shall not be used for the harvest of leeches at any time.

C.C. 1003.00 Turtle Provisions

C.C. 1003.01 Turtle Permits

Subd.1) All persons 12 years of age or older who take turtles must have in his/her possession, and on his/her person, a valid unexpired Tribal Identification Card, and a valid Natural Resources Harvest Permit.

Subd.2) The permittee may harvest turtles according to the seasons and limits stated each year by the White Earth Natural Resources Department.

C.C. 1003.02 Turtle Rules and Regulations

Subd.1) Turtles may be taken by angling, gaff, dip net, light, snare, bow and arrow, spearing, turtle hooks and hand held equipment only.

Subd.2) The use of firearms, explosives, poison, and electric shock equipment shall not be used for the harvest of turtles at any time.

C.C. 1004.00 Commercial Bear Guide Service

C.C. 1004.01 Rules and Regulations

All Commercial Bear hunting guides offering their services will meet the following criteria:

Subd.1) Tribal Bear Hunting Guides will be regulated with a permit issued by the Natural Resources Department by annual payment of a fee of \$50.00. The permit is renewable March 1 each year, for up to 5 years.

Subd.2) Tribal Bear Hunting Guide permits must be obtained before any bait stations are set up or before any guides services are provided.

Subd.3) Each Tribal Bear Hunting Guide may be permitted to have up to 10 bait stations.

Subd.4) All bait stations must be approved by the Tribal Conservation Department and the locations will be mapped by Tribal Conservation for further reference.

Subd.5) Tribal members that are using the Tribal Bear Hunting Guide services must follow the rules and regulations set forth in **C.C. 309.00 Bear, Subd.1—9.**

Subd.6) Non-Indian hunters utilizing the Tribal Bear Hunting Guide services must follow the rules and regulations set forth by the State of Minnesota.

Subd.7) Non-Indian hunters that are on Tribal land will be required to purchase a Tribal Land Access Permit from the White Earth Licensing Department before any activity.

Subd.8) All bear hunters must have on his/her person and in his/her possession all appropriate licensure and identification.

Subd.9) All bait stations will be properly marked with the name of the guide offering the service.

Subd.10) Bait stations must meet either State or Tribal regulations for the proper marking of each station.

Subd.11) Cleanup and maintenance of the bait stations will be the responsibility of the Tribal member offering the guide service.

Subd.12) Tribal Bear Hunting Guides will have 72 hours after the close of the respective season to clean up the station area and/or any other location related to this service and/or activity.

Subd.13) All aspects of this operation/service will be open to inspection by the White Earth Natural Resources and/or Conservation Department at any time.

Subd.15) Any violations of State and/or Tribal regulations will be handled by the appropriate agency and may lead to revocation of the Guide Permit and/or Land Access Permit.

C.C. 1005.00 Game Bird and Shooting Preserve Provisions

C.C. 1005.01 Game Bird Shooting Preserve Permits

Subd.1) No license shall be required for persons harvesting released game birds. Wild game may be harvested with the appropriate license within set seasons and limits.

Subd.2) All persons that leave the preserve must have a receipt from the operator with the number, species, tag numbers, and sex of birds harvested.

Subd.3) A \$350 application fee is required for the site inspection and plan approval. Permits are valid for one year beginning July 1st and ending June 30th. Renewal of permit is \$35 each year and applicants must renew by June 1st.

C. C. 1005.02 Game Bird Shooting Preserve Rules and Regulations

Subd.1) Shooting preserves shall be a minimum of 80 contiguous acres.

Subd.2) No portion of the preserve shall be within 5 miles of an existing shooting preserve.

Subd.3) Proof of ownership or lease agreement is required for all land parcels included in the preserve.

Subd.4) The boundaries of the preserve shall be posted every 500 feet with a sign stating "Licensed Shooting Preserve" in 2 inch letters.

Subd.5) Species of birds that are permitted for release are; ring-necked pheasant, quail, chukar partridge, Hungarian partridge, and turkey. Any other species that are not listed in this section must be approved prior to release.

Subd.6) No exotic species will be permitted for release.

Subd.7) The licensee must release at least 250 birds per year and all must be marked by toe clipping or enlarged nares of an anti-pecking device, and be at least 12 weeks of age.

Subd.8) Licensee must maintain receipts of all birds purchased and/or raised.

Subd.9) Harvest records must be kept for five years on the number of birds released and number harvested each day. An approved bird tag that is specific to the preserve is required to accompany all birds harvested.

Subd.10) Licensee must record the name, address, date, number of birds of each species, sex of birds (where applicable), and tag numbers given to all hunters.

Subd.11) Total harvest cannot exceed the number of birds released.

Subd.12) Applicants must be inspected for property ownership or lease, boundary posting, site plan, hunter log, and pen areas before approval. All aspects of the operation may be subject to random inspections by White Earth Natural Resources staff and/or Conservation Officers for compliance at any time.

Subd.13) An annual report of the number of birds released, number harvested, names and addresses of hunters, and number of birds purchased and/or raised is required for license renewal.

Subd.14) The operator must keep a record of all birds sold, either by harvest, live to others, or dead. Dead birds that are packaged and sold must be recorded and given a receipt to the recipient.

C.C. 1005.03 Game Bird Shooting Preserve Seasons and Limits

Subd.1) The harvest season of the preserve shall be August 1st to March 31.

C.C. 1006.00 Commercial Big Game Harvest Preserve Provisions

C.C. 1006.01 Definition

Big Game - Members of the cervidae family (elk, deer, etc) and bovidae (bison) that are raised for the purpose of harvesting, breeding stock, producing meat or animal by-products, shooting, or as pets.

C.C. 1006.02 Permit

Subd.1) A valid permit from the White Earth Natural Resources Department (WENRD) is required to commercially raise big game and/or operate a Commercial Big Game Harvest Preserve. Permits will be given only to enrolled members who own and operate the Big Game Harvest Preserve.

Subd.2) The White Earth RTC and WENRD will allow no more than 6 valid permits at any time. A period of 5 years will be used to study the effects of the commercial enterprise to the surrounding environment, economy, and general well-being of the Reservation as a whole.

Subd.3) A permittee must purchase a Big Game Harvest Preserve Permit by payment of \$350.00 for original application and renewable each year for \$35.00. Permit is valid from September 1 to August 31 of each year.

Subd.4) A complete application and site inspection will be required to obtain a valid permit. No permit will be issued unless it is deemed that there will be no adverse affect on wild cervidae populations. All requirements of the Big Game Harvest Preserve must be met before the granting of a permit. The WENRD will have 30 days to process an application and conduct inspections of the proposed operation.

Subd.5) Permittee must renew prior to August 1 of each year. It will be deemed a violation to conduct any of the activities stated in this permit without possessing a valid permit.

Subd.6) A valid permit does not exempt permittee from any local, county, state, or city ordinances that may apply to the purpose and/or location of the operation.

C.C. 1006.03 Rules and Regulations

Subd.1) Permittee must receive approval to possess any other species that are not of the Cervidae or Bovidae family.

Subd.2) All parts and aspects of the Big Game Harvest Preserve shall be open to inspection by any staff of the White Earth Natural Resources Department at any time.

Subd.3) Applicant and/or permittee must prove ownership of the land used in the Big Game Harvest Preserve. If land is being leased, a signed, legal document proving a legal lease of the property is required.

Subd.4) All wild cervidae must be removed from the harvest preserve property prior to issuance of the permit.

Subd.5) All animals must be contained in completely fenced pens at all times to prevent intermixing with wild species and escape of captive species.

Subd.6) Shooting preserve must be fenced to meet the minimum requirements stated below:

- a) Fences shall be minimum of eight feet above ground level of which the bottom six feet must be mesh (maximum mesh size shall be 12 ½" X 7"). The remaining two feet may be smooth, barbed or woven wire strands spaced no more than ten inches apart. Fencing shall start no more than four inches above ground.
- b) Minimum wire gauges shall be 14 ½ gauge woven hi-tensile and 12 ½ gauge conventional fence.
- c) All gates to pens and holding facilities shall be locked, or consecutive (double), or self-closing gates.
- d) Posts must be a minimum of four inches in diameter for wood or equivalent and be spaced no more than sixty feet apart. A post or stay is required every twenty feet and must be at least eight feet above ground. Corners shall be braced with wood or equivalent material.

Subd.7) The harvest preserve portion must be separated from the breeding pens and pastures as approved by the WENRD. The harvest preserve portion must be a minimum of 40 contiguous acres and contain adequate areas of cover for concealment.

Subd.8) Fences and boundaries must be clearly marked and posted with visible signs at a minimum of 500 feet apart.

Subd.9) Permittee must notify WENRD of any substantive changes to their facility, such as fences, acreage, additional parcels, and species.

Subd.10) A hunting license is not required to harvest authorized animals on the preserve.

Subd.11) The open season for the harvest preserve shall be August 1 to March 31.

Subd.12) A person may take farmed big game with legal firearms or archery as stated in section **C.C. 1006.00 Commercial Big Game Harvest Preserve Provisions.**

Subd.13) The permittee may establish the cost for taking animals, shooting hours, weapon restrictions, season length, age, sex, and number animals that can be taken by a hunter. These provisions must be as restrictive or more restrictive than any subdivision of this section.

Subd.14) All harvested big game must be tagged appropriately to identify and authenticate the origination of the animal for legal transport. The WENRD will establish the correct marking tag for transportation, See **C.C. 103.00 Transport Permits.**

Subd.15) No animals shall be sold, offer for sale, barter, exchange, purchased from, or otherwise transferred to or from any person(s), unless they have a legally licensed Commercial Big Game operation.

Subd.16) Any animals that escape from captivity must be reasonably pursued for recapture by permittee. Permittee shall immediately contact WENRD to inform of any escaped animals.

Subd.17) Any escaped animals that are legally harvested by a licensed hunter in compliance with the Conservation Code and approved seasons and limits is deemed a legal killing and will not be liable to the owner for such killing. Any escaped animal that is not destroyed or captured within 48 hours of escape will be deemed lost and open to killing by WENRD.

Subd.18) Any violation of the White Earth Conservation Code pertaining to this section may result in revocation of this permit at any time.

C.C. 1006.04 Records/Accreditation

Subd.1) The permittee shall keep records of licenses sold, names, numbers and species of animals harvested, dates of harvest, tags and markings of big game taken, and numbers and species of big game raised. These records shall be open to inspection by the WENRD at any time. An annual report of these records will be required prior to the renewal of the permit each year.

Subd.2) All big game raised must be registered and approved by the MN Board of Animal Health (BAH). All big game shall be marked with a permanent tattoo, electronic implant, ear tag or other approved methods of marking for identification accepted by BAH.

Subd.3) All captive big game must originate from stock that are accredited to test free of brucellosis, bovine tuberculosis, and chronic wasting disease (CWD). No animals should be purchased from a stock that is known to contain any infectious diseases or viruses. Failure to produce proper documents and certificates for the above requirements of any existing captive animals or the importation of purchased animals will be a violation.

Subd.4) Any animal(s) suspected of being exposed or infected with a disease may be requested by the WENRD, U.S. Department of Agriculture or BAH for inspection by an accredited veterinarian. Such inspections shall be at the expense of the licensee. Any diseased animals must be properly disposed of in accordance with statutes and regulations set forth by BAH.

Subd.5) All captive animal mortalities must be reported to the WENRD immediately to determine the need for tissue testing for the detection of an infectious disease. All mortalities of animals 16 months or older are required to be tested for CWD. All tests shall be conducted by an accredited veterinarian and all costs will be the responsibility of the permittee.

C.C. 1007.00 Commercial Fur Buyer Provisions

C.C. 1007.01 Commercial Fur Buyer Permits

Subd.1) The fur buyer must obtain a Commercial Fur Buyer's License by annual fee of \$35.00. The license is renewable as of June 1 of each year.

Subd.2) The license is renewable up to 5 years provided there have been no convictions for violations of the license or Conservation Code, all reports get submitted in a timely and accurate manner, furs are actively and regularly purchased at least 3 months of the year, and the fur buyer pays an annual fee of \$35.00.

C.C. 1007.02 Rules and Regulations

Subd.1) A fur buyer can only purchase furs that have been legally obtained. All furs that require special registration must be properly registered and tagged.

Subd.2) The fur buyer shall not utilize this license to trap more furbearers than is regulated in Subd.7), **C.C. 102.00 General Provisions and Prohibited Acts.**

Subd.3) The fur buyer must obtain a Retention Permit to retain furs more than 5 days after the close of the season.

Subd.4) All aspects of the operation shall be open to inspection and observation at any time by the White Earth Conservation and/or Natural Resources Department including: transport equipment, holding facilities, storage buildings, or the permittee's place of business.

Subd.5) The fur buyer shall keep records on forms provided by the Natural Resources Department to include: tag number, whom the furs were acquired from, number of furs, number of each species, and who the furs were sold to. Forms shall be due on June 1 of each year.

Subd.6) Violation of any of the provisions of the Conservation Code subjects the licensee to immediate temporary revocation of the license until such time that a full hearing may be heard of the case. If the person is found guilty of any of the provisions of the Conservation Code, or his/her license, the permittee is subject to permanent loss of the license.

Subd.7) The White Earth Tribal Council reserves the right to, at its discretion, require a \$1000.00 bond payable to the White Earth Tribal Council to be utilized as payment of fines, penalties, or for cleanup of violations if permittee is convicted of a violation of the terms of the license.

C.C. 1008.00 Commercial Taxidermy Provisions

C.C. 1008.01 Commercial Taxidermy Permits

Subd.1) Licensure. A person must obtain a business license from the White Earth Reservation Tribal Council to buy or sell wild animals, tan animal hides, dress raw furs or mount specimens of wild animals, or to otherwise engage in a taxidermy business operation that generates revenue from others within the reservation boundaries.

Subd.2) Recordkeeping. Complete records of all transactions and activities covered by the taxidermy license must be kept on animals, fish or other species which are mounted, tanned or dressed. Reports must be submitted annually to the White Earth Natural Resource Department by March 15 for the preceding license year.

Subd.3) The records required under this subdivision must also be made available for inspection upon request by the White Earth Reservation Department of Natural Resources or its authorized agents. The records must be preserved and available for two years after the expiration of any license that required them.

The records must show:

- a) The names and addresses of persons from whom wild animals were obtained and to whom they were transferred;
- b) The dates of receipt, shipment and sale of wild animals;
- c) detailed descriptions of the number and type of wild animals purchased, sold and shipped;
- d) Serial numbers of seals, tags or permits required to be attached to the wild animals; and

- e) Trapping license numbers for protected fur-bearing animals, unless the trapper is exempt from the license requirement, which must be noted.

Subd.4) Federal Migratory Bird Permit. Before mounting or otherwise performing taxidermy work on migratory birds or their parts, nests or eggs, a taxidermist must obtain the required federal taxidermy permit for migratory birds, which includes eagles. The permit allows a taxidermist to temporarily possess another's legally acquired bird. Without a permit, it would be illegal for a taxidermist to possess migratory birds belonging to others. With the permit, any legally acquired migratory bird species (acquired pursuant to a salvage permit, by a natural resources office or agency during the course of its duties, via a salvage permit, via hunting, via the National Eagle Repository) can be mounted by a taxidermist.

Subd.5) U.S. Fish and Wildlife Service. The federal taxidermy permit is issued by the U.S. Fish and Wildlife Service ("USFWS"). The permit fee is \$100 and the permit is valid for 5 years. Applications for the permit are available at: <http://www.fws.gov/forms/3-200-8.pdf> . Additional Act requirements and resources of the USFWS for other protected species are listed below and can be found at: <http://www.fws.gov/permits/ltr/ltr.shtml>.

- a) Bald and Golden Eagle Protection Act (16 U.S.C. 668), 50 CFR 22;
- b) Endangered Species Act of 1973 (16 U.S.C. 1531-1544), 50CFR 17;
- c) Migratory Bird Treaty Act (16 U.S.C. 703-712), 50 CFR 21;
- d) Marine Mammal Protection Act of 1972 (16 U.S.C. 1361, *et. seq.*), 50 CFR 18;
- e) Wild Bird Conservation Act (16 U.S.C. 4901-4916), 50 CFR 15;
- f) Lacey Act: Injurious Wildlife (18 U.S.C. 42), 50 CFR 16;
- g) Convention on International Trade in Endangered Species of Wild Fauna and Flora (TIAS 8249), <http://www.cites.org/> , 50 CFR 23;
- h) General Provisions, 50 CFR 10;
- i) General Permit Procedures, 50 CFR 13; and
- j) Wildlife Provisions (Import/export/transport), 50 CFR 14.

C.C. 1008.02 Commercial Possession of Wild Animals

Subd.1) Possession of unlawful animals brought into reservation prohibited. A person may not possess a wild animal that has been unlawfully taken, bought, sold, or possessed outside the reservation, or unlawfully shipped into the reservation.

Subd.2) Storage of protected wild animals. A person that stores protected wild animals for others must plainly mark the package, in ink, with the name and address of the owner, the Natural Resource Harvest permit number of the person taking the animal, and the number of species in the package.

Subd.3) License not required for animals acquired by gift. Lawfully taken protected wild animals may be transferred by gift. A person is not required to have a license or permit to possess and transport protected wild animals acquired by gift.

Subd.4) Exceptions. This section does not apply to mounted specimens of wild animals, antlers, tanned hides, and dressed furs lawfully taken.

Subd.5) Importation of hunter-harvested Cervidae (Deer). Importation into the reservation of hunter-harvested Cervidae carcasses from known chronic wasting disease (CWD) or Tuberculosis Disease (TB) endemic areas, as determined by the USDA Animal Plant Health Inspection Service (APHIS), is prohibited, except for cut and wrapped meat, quarters or other portions of meat with no part of the spinal column or head attached, antlers,

hides, teeth, finished taxidermy mounts, and antlers attached to skull caps that are cleaned of all brain tissue. Hunter- harvested Cervidae carcasses taken from chronic wasting disease or Tuberculosis Disease endemic areas outside the reservation may be transported on a direct route through the reservation.

Subd.6) Possession of live Cervidae. A person may not possess live Cervidae, except as authorized by permit of the White Earth Natural Resource Department.

C.C. 1008.03 Transport Permits

Subd.1) See **C.C. 103.00 Transport Permits**

C.C. 1009.00 Commercial Harvest of Aquatic Vegetation

C.C. 1009.01 Aquatic Vegetation Harvest Permits

Subd.1) A valid Commercial Aquatic Vegetation Harvest permit is required prior to any harvest of aquatic plants. Permits are valid for one year at the cost of \$50.

Subd.2) Permits are valid from March 1st to last day of February each year.

Subd.3) Permits are valid only for the permittee and two helpers; all persons involved in the harvest or transportation of aquatic vegetation must be listed on the permit.

Subd.4) Permittee and the two helpers must each have on his/her person and in his/her possession a valid unexpired Tribal Identification Card and a current Natural Resources Harvest Permit while conducting the activities of the permit.

Subd.5) This permit is valid for the harvest of aquatic plants only. Any transfer of aquatic plants to another body of water must receive prior approval from the Natural Resources Department.

C.C. 1009.02 Aquatic Vegetation Harvest Rules and Regulations

Subd.1) Prior to the approval of a permit, each applicant must list the species of aquatic plants to be harvested and the locations of the wetlands in which they are harvesting from. The Natural Resources Department may limit the species and locations that are available for harvest of aquatic plants.

Subd.2) Harvest of all aquatic plants shall be done by hand only. Use of any mechanized equipment that aids in the harvest of aquatic plants is strictly prohibited.

Subd.3) Permittee is required to send monthly reports stating the poundage of each aquatic plant species harvested from each wetland stated in the permit.

Subd.4) The Natural Resources Department may revoke a permit at anytime if the activities listed in the permit are deemed to be detrimental to the environment, fisheries, wildlife, and the native plant communities affected by the permit.

Subd.5) Any violation of this section or requirements stated in the permit, or any violation of this Code is punishable in White Earth Tribal Court and may result in the immediate revocation of the permit.

C.C. 1010.00 Commercial Forestry Provisions

C.C. 1010.01 Bough Harvesting Permits

Subd.1) A Bough Harvesting Permit issued by the White Earth Licensing Department is required for any removal of balsam fir boughs from White Earth Tribal lands.

Subd.2) Permittees must be an enrolled member of the White Earth Band of Chippewa to obtain a Bough Harvesting Permit.

Subd.3) Each person in the harvesting party must have in his/her possession, and on his/her person, a Natural Resources Harvest Permit, valid unexpired Tribal Identification Card, and a Bough Harvesting Permit during harvesting. People under the age of 18 do not require an individual permit but must be accompanied by a permitted adult. Permitted adults will be responsible and liable for the actions of the minor.

Subd.4) The fee for each Bough Harvesting Permit is \$10.00, and is valid for one season only.

C.C. 1010.02 Bough Harvesting Rules and Regulations

Subd.1) Bough Harvesting Permits are valid on all Tribal and Band lands within the exterior boundaries of the White Earth Reservation, but are not valid on any other private or public lands within that boundary. Harvesting boughs off Reservation lands may require land owner permission and additional permits.

Subd.2) A harvesting Guideline will be issued with each permit. All boughs must be harvested in accordance with the guidelines sheet to ensure healthy regeneration and availability of balsam boughs for future harvesting.

Subd.3) It is prohibited for bough harvesters to cut down the entire balsam fir tree to obtain the boughs.

**WHITE EARTH RESERVATION TRIBAL COUNCIL
A/K/A WHITE EARTH BUSINESS COMMITTEE
WHITE EARTH BAND OF CHIPPEWA INDIANS**

Resolution No. 057-15-001

- WHEREAS,** the White Earth Reservation Tribal Council is the duly elected governing body of the White Earth Reservation pursuant to Article IV, Section I, of the revised constitution and bylaws of the Minnesota Chippewa Tribe, as amended, and organized under Section 16, of the Act of June 18, 1934 (48 Stat. 984), and
- WHEREAS,** the White Earth Reservation Tribal Council, also known as the White Earth Reservation Business Committee, is the duly authorized governing body of the White Earth Band, and
- WHEREAS,** the White Earth Reservation Tribal Council has previously enacted the White Earth Reservation Conservation Code for the purposes of protecting, managing and enhancing natural resources within the exterior boundaries of the White Earth Reservation for the benefit of White Earth Tribal members, and
- WHEREAS,** the White Earth Reservation Tribal Council has enacted Tribal law designating all lands within the 1867 exterior boundaries of the White Earth Reservation as a wolf sanctuary where absolutely no hunting or trapping of wolves is permitted by either Indians or non-Indians, and
- WHEREAS,** the White Earth Reservation Tribal Council has determined that the White Earth Reservation Conservation Code should be amended so as to incorporate the provisions of the wolf sanctuary protections, together with effective enforcement mechanisms to carry out the terms of the wolf sanctuary proclamation, now

THEREFORE BE IT RESOLVED, that the White Earth Reservation Tribal Council hereby adopts the following amendments to the White Earth Reservation Conservation Code:

Definitions

NEW LANGUAGE

Subd. 91) **White Earth Tribal Court:** shall mean the Court established by the governing body of the White Earth Band through the adoption of the White Earth Band of Chippewa Judicial Code on November 3, 1997.

OLD LANGUAGE –to be removed

White Earth Tribal Court: Shall mean the Reservation Court established by the Minnesota Chippewa Tribal Constitution and shall have the authority and responsibility for adjudicating violations of these regulations.

C.C. 100.07 Jurisdiction

ADDED NEW SUBDIVISION:

Subd. 3) The jurisdiction of the White Earth Tribal Court shall extend to non-Indians in the case of hunting or trapping violations involving wolves, and such jurisdiction shall be civil in nature. Civil penalties with respect to non-Indians found to have engaged in hunting or trapping violations involving wolves shall be limited to monetary fines not to exceed \$5,000.00 for each offense. Additionally, any equipment, firearms, motor vehicles used during the course of wolf hunting or trapping shall be subject to civil forfeiture.

ADDED NEW SECTION:

CC 303.01 Wolf Hunting and Trapping Prohibited

Absolutely no hunting or trapping of wolves by Indians or non-Indians is permitted on any lands within the exterior boundaries of the White Earth Reservation.

By formal action on August 20, 2012, the governing body of the White Earth Band declared all territory within the exterior boundaries of the White Earth Reservation a Ma'iingan or Wolf Sanctuary. No hunting or trapping of Ma'iingan shall be allowed within the original 1867 exterior boundaries of the White Earth Reservation.

We do hereby certify that the foregoing resolution was adopted by a vote of 4 for, 0 against, 0 silent, a quorum being present at a special meeting of the White Earth Reservation Tribal Council held on November 3, 2014 in White Earth, Minnesota.



Erma J. Vizenor, Chairwoman

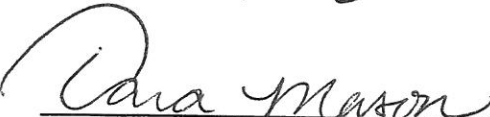

Tara Mason, Secretary/Treasurer